

PAJUNK®



REGIONAL ANESTHESIA
& PAIN MANAGEMENT

Regional Anesthesia Product Catalog





LEARN MORE
ABOUT NRFit

WHEN SOMETHING **FITS PERFECTLY**
THE RESULTS CAN BE LIFE CHANGING

NRFit™ – *Always the perfect match.*

NRFit reduces the risk of misconnections in
Regional Anesthesia, preventing wrong route
medication errors that may lead to fatal outcomes.



What is NRFit?

NRFit is a new, dedicated connector for neuraxial and regional block devices defined by ISO 80369-6 to improve patient safety. Devices with NRFit connectors are not compatible with Luer connectors, reducing the risk of accidental misconnections of patient lines, which can lead to permanent damage or death.

The PAJUNK® Service Model for a Successful Conversion

In addition to offering a complete NRFit portfolio of regional anesthesia products, Pajunk is available to offer their expertise in converting your neuraxial products from Luer to NRFit. Various areas such as pharmacy, procurement, storage, training, maintenance, and end users are affected by the conversion process. Pajunk supports you with the necessary information, and accompanies you in the development of a conversion plan, leaving you with more time to focus on what matters most: **Patient Safety.**

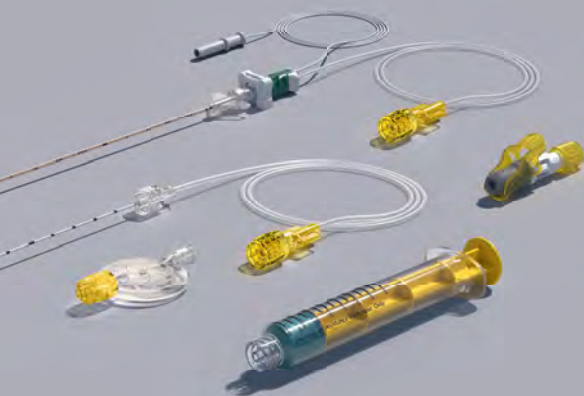

REQUEST INFORMATION & SAMPLES NOW!
info@pajunk-usa.com · pajunkusa.com

PAJUNK®

Table of Contents

1 | SPINAL ANESTHESIA

<i>SPROTTE®</i>	6
<i>Sprotte Introducer</i>	8

2 | EPIDURAL ANESTHESIA

<i>TuohySono</i>	10
<i>Tuohy</i>	11
<i>Caudal</i>	12
<i>EpiLong Catheters</i>	13
<i>EpiLong Soft Sono</i>	14
<i>EpiLong Sets</i>	15
<i>StimuLong Sono Tsui</i>	16

3 | COMBINED SPINAL-EPIDURAL ANESTHESIA

<i>EpiSpin Lock Needles</i>	20
<i>EpiSpin II Safety</i>	21

4 | NERVE BLOCKS

<i>Single Shot Needles</i>	
<i>SonoPlex® II</i>	24
<i>SonoBlock II</i>	25
<i>SonoTAP® II</i>	26
<i>TuohySono</i>	27
<i>UniPlex®</i>	28

Table of Contents

4 | NERVE BLOCKS

Catheter Sets

<i>E-Cath</i> [®]	29
<i>E-Cath Plus</i>	30
<i>E-Cath Stim</i>	31
<i>SonoLong Echo</i>	32
<i>SonoLong Sono</i>	33
<i>SonoLong Curl Echo</i>	34
<i>StimuLong Sono II</i>	35
<i>PlexoLong NanoLine</i> [®]	36

Nerve Stimulators

<i>MultiStim ECO</i>	38
<i>MultiStim SENSOR</i>	39

Pain Pump

<i>Nimbus</i> [®] II PainPRO	40
---------------------------------------	----

5 | WOUND INFILTRATION

Continuous Wound Infiltration

<i>InfiltraLong</i>	42
---------------------	----

6 | ACCESSORIES

<i>EpiLong VPC, LOR, NerveGuard, Clamping Adapter, FixoCath, Filter & FixoLong, Injection Tubing, Safersonic Probe Covers, NRFit</i> [®] Accessories	44
---	----

7 | PROCEDURE TRAYS

<i>Regional Anesthesia Procedure Trays</i>	48
--	----

Spinal Anesthesia

*Needles and Catheters for Atraumatic
Spinal Anesthesia*



SPROTTE®

Needles for Atraumatic Spinal Anesthesia with Standard Hub or Magnifying Hub

- 1 Atraumatic Tip Design
- 2 Lateral Eye
- 3 Precision-ground Metal Stylet
- 4 Standard Hub
- 5 Alternatively: Magnifying Hub
- 6 Highest Processing Quality



Product advantages at a glance:

- Atraumatic tip design minimizes chance of PDPH¹
- Unobstructed CSF backflow
- Smooth gliding properties and improved tactile feedback

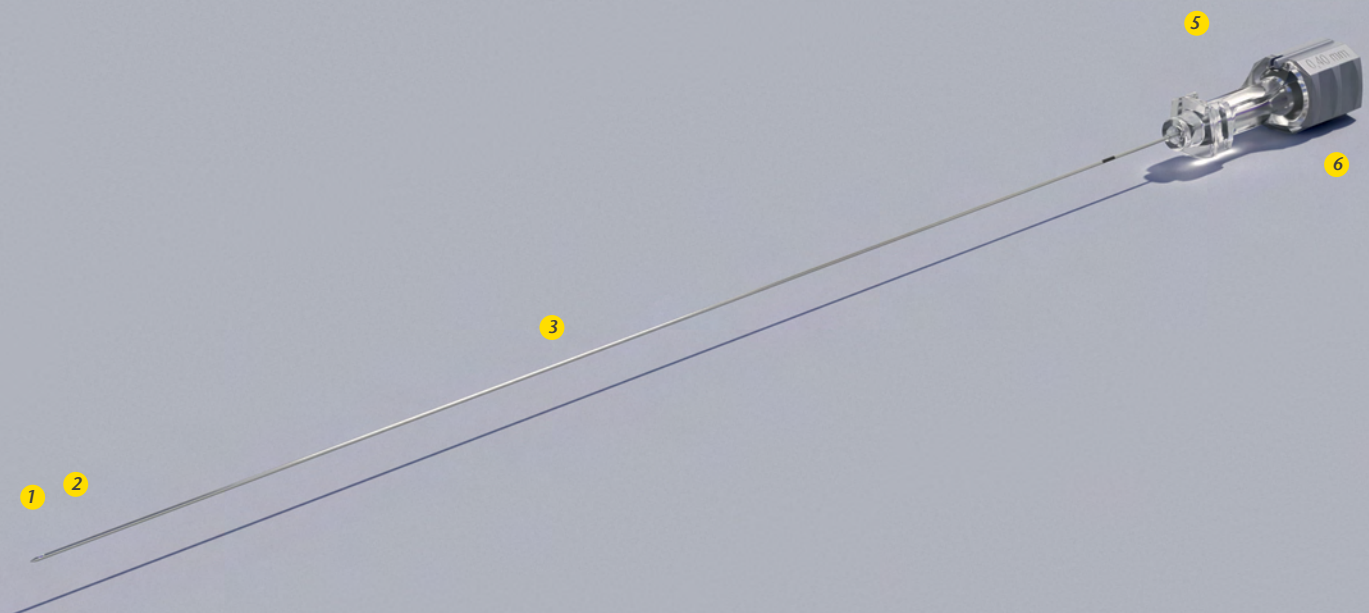

1. Cesarini, M. et al. Sprotte needle for intrathecal anaesthesia for Caesarean section: incidence of postdural puncture headache, *Anaesthesia* 1990; 45: 646–658

Sprotte Needles with Standard Hub / Magnifying Hub

Description	Introducer	Item no. Standard hub	Item no. Magnifying hub	NRFit® Item no. Magnifying hub	PU
29G x 90 mm (3 1/2")	30 mm (1 1/5")		501151-28A		25
• 27G x 25 mm (1")			101151-27A		25
• 27G x 35 mm (1 1/3")			111151-27A		25
27G x 70 mm (2 3/4")	30 mm (1 1/5")		121151-27B		25
27G x 90 mm (3 1/2")	30 mm (1 1/5")		121151-27A	021163-27A	25
27G x 90 mm (3 1/2")	40 mm (1 3/5")			211163-27A	25
27G x 103 mm (4")	40 mm (1 3/5")		141151-27A	041163-27A	25
27G x 120 mm (4 3/4")				231163-27A	10
27G x 120 mm (4 3/4")	40 mm (1 3/5")		151151-27A	031163-27A	10
27G x 123 mm (4 4/5")			231151-27A		10
27G x 150 mm (6")	40 mm (1 3/5")		171151-27A		10
• 25G x 35 mm (1 1/3")		001151-29E		001163-29E	25
25G x 70 mm (2 3/4")	30 mm (1 1/5")	021151-29B			25
25G x 90 mm (3 1/2")		501151-29A		501163-29A	25
25G x 90 mm (3 1/2")	30 mm (1 1/5")	021151-29A	511151-29A	021163-29A	25
25G x 90 mm (3 1/2")	40 mm (1 3/5")			211163-29A	25
25G x 103 mm (4")	40 mm (1 3/5")	041151-29A	161151-29A	041163-29A	25
25G x 120 mm (4 3/4")		031151-29A		031163-29A	10
25G x 120 mm (4 3/4")	40 mm (1 3/5")	051151-29A	171151-29A	051163-29A	10
25G x 123 mm (4 4/5")		151151-29A			10
25G x 150 mm (6")				261163-29A	10
25G x 150 mm (6")	40 mm (1 3/5")	061151-29A			10
• 24G x 25 mm (1")		001151-30D		001163-30D	25
• 24G x 35 mm (1 1/3")		001151-30E		001163-30E	25
• 24G x 50 mm (2")	15 mm (1/2")	021151-30F			25
24G x 70 mm (2 3/4")		001151-30B			25
24G x 70 mm (2 3/4")	30 mm (1 1/5")	021151-30B		021163-30B	10
24G x 90 mm (3 1/2")		001151-30A		001163-30A	25
24G x 90 mm (3 1/2")	30 mm (1 1/5")	121151-30A		121163-30A	25
24G x 103 mm (4")	40 mm (1 3/5")	021151-30A		021163-30A	25
24G x 120 mm (4 3/4")		031151-30A			10
24G x 120 mm (4 3/4")	40 mm (1 3/5")	041151-30A		041163-30A	10
24G x 150 mm (6")		141151-30A			10
24G x 150 mm (6")	40 mm (1 3/5")	131151-30A		131163-30A	10
24G x 200 mm (8")	40 mm (1 3/5")	0051151-30			10
• 22G x 50 mm (2")		071151-30C		071163-30C	25
22G x 70 mm (2 3/4")		051151-30C			25
22G x 70 mm (2 3/4")	30 mm (1 1/5")	051151-30B			25
22G x 90 mm (3 1/2")		001151-30C		001163-30C	25
22G x 90 mm (3 1/2")	30 mm (1 1/5")	021151-30C		021163-30C	25
22G x 103 mm (4")		521151-30C		521163-30C	25
22G x 103 mm (4")	40 mm (1 3/5")	221151-30C		221163-30C	25
22G x 120 mm (4 3/4")		031151-30C		031163-30C	10
22G x 120 mm (4 3/4")	40 mm (1 3/5")	131151-30C		131163-30C	10
22G x 150 mm (6")		041151-30C			10
22G x 150 mm (6")	40 mm (1 3/5")	141151-30C		141163-30C	10
22G x 200 mm (8")	40 mm (1 3/5")	0041151-30			10

• Small patient product

SPROTTE® Introducer

Matching Introducer for
Sprotte Spinal Needles

- 1 Facet Tip
- 2 Matches Perfectly to Each Spinal Needle Size

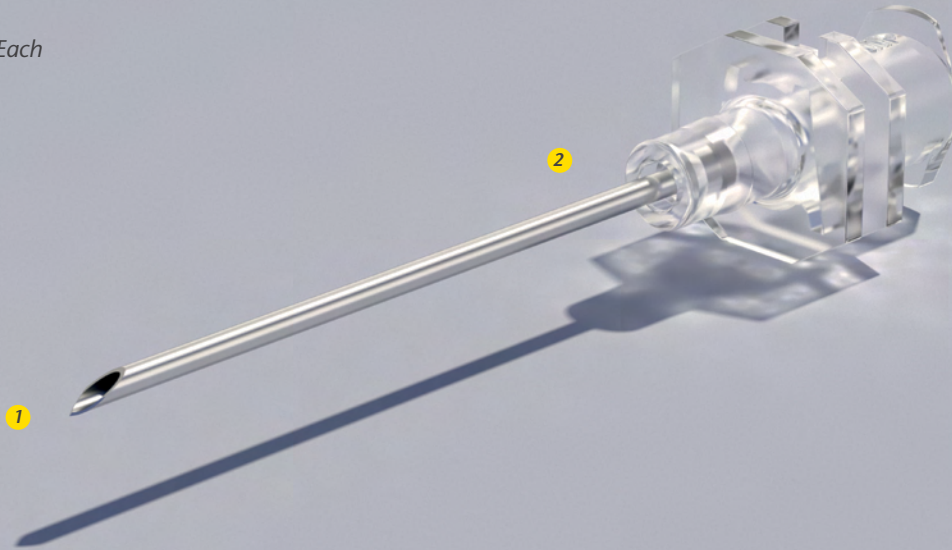

Product advantages at a glance:

- Minimal reduction of useable working length of the spinal needle
- Funnel-shaped hub to reduce chance of spinal needle tip damage during insertion

Description	Sprotte Size	Item no.	NRFit® Item no.	PU
22G x 30mm (0.70mm x 1 1/5")	27G, 29G	071151-30L		25
22G x 40mm (0.70mm x 1 3/5")	27G, 29G	071151-30M		25
21G x 30mm (0.80mm x 1 1/5")	24G, 25G	021151-30L	021163-30L	25
21G x 40mm (0.80mm x 1 3/5")	24G, 25G	021151-30M		25
20G x 30mm (1.00mm x 1 1/5")	22G	001151-30L	001163-30L	25
20G x 40mm (1.00mm x 1 3/5")	22G	001151-30M	001163-30M	25
19G x 30mm (1.10mm x 1 1/5")	21G	051151-30L		25
17G x 30mm (1.30mm x 1 1/5")	19G	091151-30L		25

Epidural Anesthesia

*Wide Range of
Needles and Catheter Systems*

TuohySono

Echogenic, Single Shot Epidural Injection Needles

- 1 Echogenic Needle Tip
- 2 Cornerstone Reflectors
- 3 Depth Markings
- 4 Precision-ground Metal Stylet
- 5 Detachable Plastic Wings

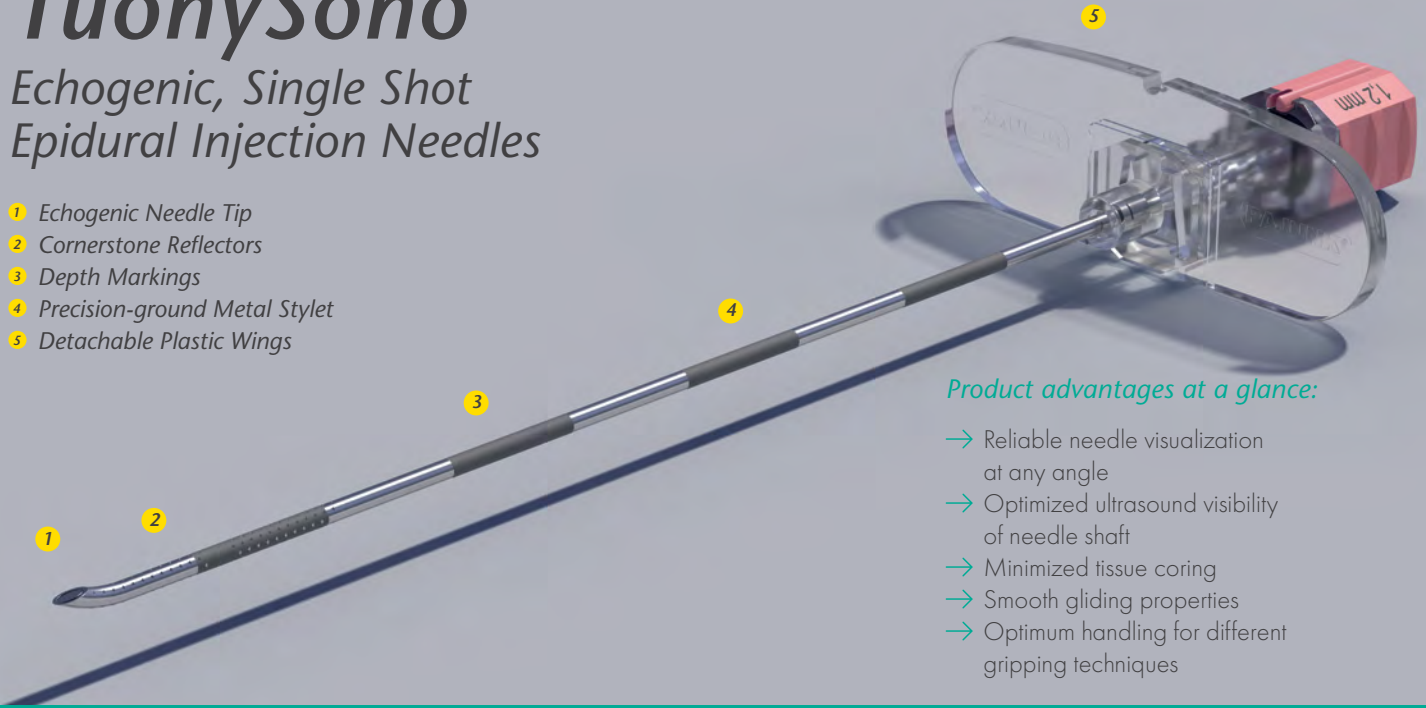

Product advantages at a glance:

- Reliable needle visualization at any angle
- Optimized ultrasound visibility of needle shaft
- Minimized tissue coring
- Smooth gliding properties
- Optimum handling for different gripping techniques

Description	Item no.	PU
20G x 103 mm (4")	1085-4G103	25
• 18G x 50 mm (2")	1085-4K050	25
18G x 90 mm (3 1/2")	1085-4K090	25
18G x 120 mm (4 3/4")	1085-4K120	10
18G x 150 mm (6")	1085-4K150	10
17G x 90 mm (3 1/2")	1085-4M090	25
17G x 150 mm (6")	1085-4M150	10

- Small patient product

Tuohy

Single Shot Epidural Injection Needles

- 1 Depth Markings
- 2 Precision-ground Metal Stylet
- 3 Detachable Plastic Wings

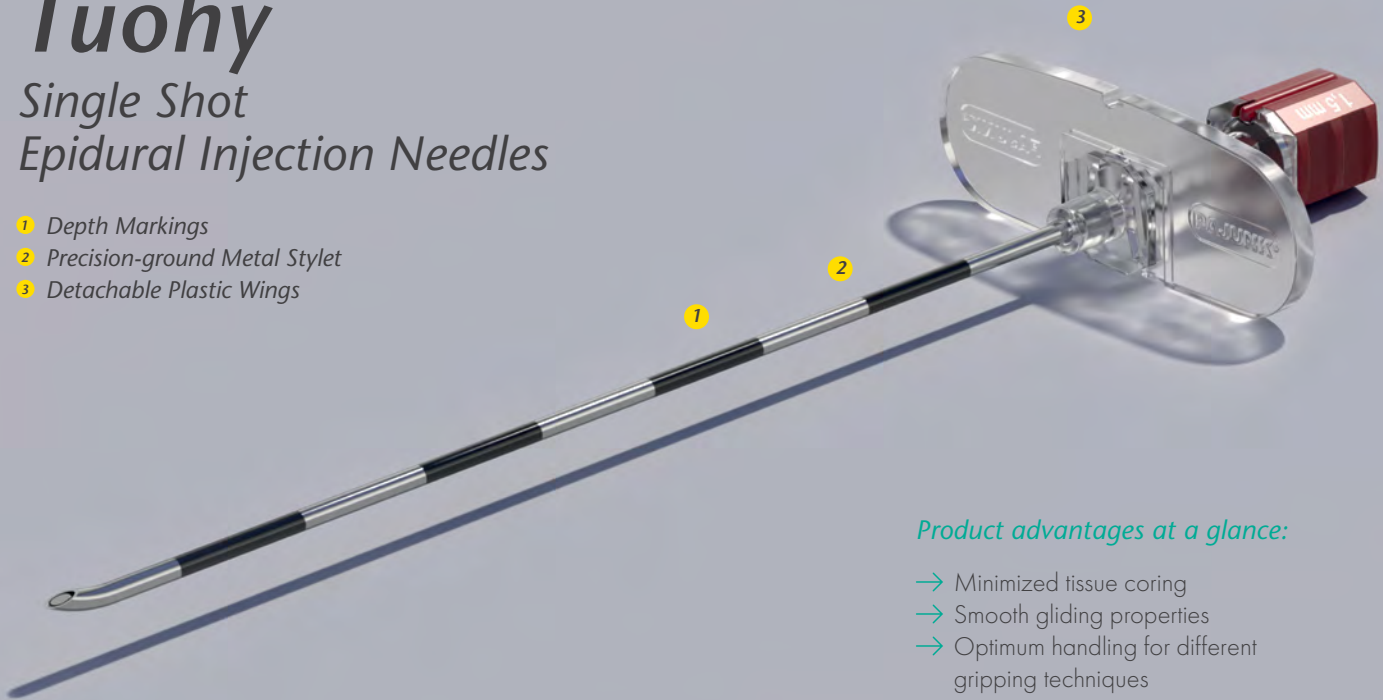

Product advantages at a glance:

- Minimized tissue coring
- Smooth gliding properties
- Optimum handling for different gripping techniques

Description	Item no. Metal stylet	Item no. Plastic stylet	NRFit® Item no. Plastic stylet	PU
22G x 90mm (3 1/2")	1150-4E090			25
22G x 100mm (4")	1150-4E103			25
20G x 90mm (3 1/2")	1150-4G090			25
20G x 100mm (4")	1150-4G103			25
20G x 120mm (4 3/4")	1150-4G120			10
20G x 150mm (6")	1150-4G150			10
• 19G x 50mm (2")	1150-4I050			25
19G x 80mm (3 1/5")	1150-4I080			25
19G x 90mm (3 1/2")	1150-4I090	1150-6I091		25
• 18G x 50mm (2")	1150-4K050			25
18G x 80mm (3 1/5")	1150-4K080	1150-6K081	1166-6K081	25
18G x 90mm (3 1/2")	1150-4K090	1150-6K091	1166-6K091	25
18G x 120mm (4 3/4")	1150-4K120			10
18G x 150mm (6")	1150-4K150			10
18G x 200mm (8")	1150-4K200			10
17G x 80mm (3 1/5")	1150-4M080			25
17G x 90mm (3 1/2")	1150-4M090	1150-6M091	1166-6M091	25
17G x 120mm (4 3/4")	1150-4M120			10
17G x 150mm (6")	1150-4M150			10
17G x 200mm (8")	1150-4M200			10
16G x 80mm (3 1/5")	1150-4O080	1150-6O081	1166-6O081	25
16G x 90mm (3 1/2")	1150-4O090	1150-6O091	1166-6O091	25
16G x 120mm (4 3/4")	1150-4O120			10

- Small patient product

Caudal

Injection Needles with Crawford Bevel

- 1 Crawford Tip
- 2 Depth Stop and Depth Markings
- 3 Detachable Plastic Wings

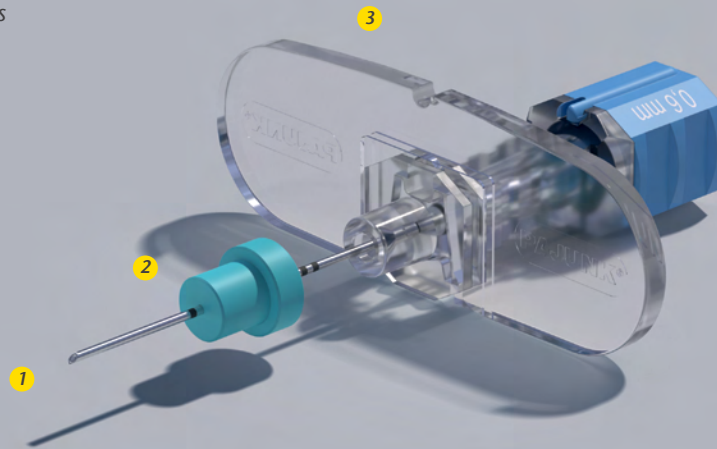

Product advantages at a glance:

- Easy identification of puncture depth
- Optimum handling for different gripping techniques

Description	Item no.	NRFit® Item no.	NRFit Sets* Item no.	PU
• 25G x 25 mm (1")	1149-12C025	1163-12C025	1166-12C025	25
• 25G x 50 mm (2")	1149-12C050	1163-12C050	1166-12C050	25
• 23G x 25 mm (1")	1149-12D025			25
• 22G x 40 mm (1 3/5")	1149-12E040	1163-12E040	1166-12E040	25
22G x 60 mm (2 1/4")	1149-12E060	1163-12E060	1166-12E060	25
22G x 80 mm (3 1/5")	1149-12E080	1163-12E080	1166-12E080	25

• Small patient product

*NRFit Sets include a Filter Needle NRFit 18G x 50 mm (2") , Syringe NRFit 10 ml Slip

EpiLong Catheters

Catheters for Epidural Anesthesia

- 1 Open Tip or Lateral Openings
- 2 Standard and Soft Catheters
- 3 Depth Markings

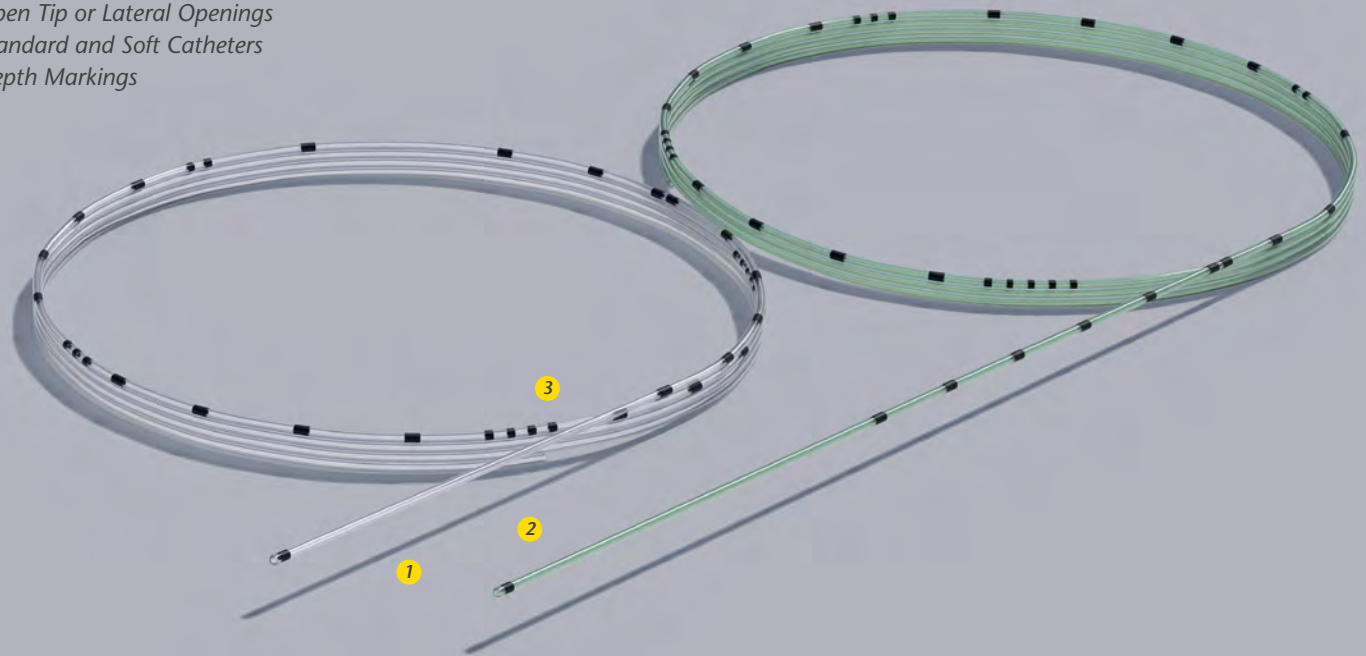

Product advantages at a glance:

- Improved flow of anesthetic
- Kink resistant (Soft Catheter)

Description	Closed / Open Tip	Lateral openings	Item no.	NRFit Item no.	PU	Steel stylet	Stainless steel helical coil	Clamping Adapter
20G x 90 cm (35"), Soft Catheter	closed	6	041151-37R	041163-37R	10	•	•	
19G x 90 cm (35"), Soft Catheter	closed	6	041151-37P		10	•	•	
20G x 90 cm (35")	closed	3	001151-37C		10	•		•
20G x 90 cm (35")	closed	3	021151-37C	021163-37C	10			•
20G x 90 cm (35")	open		011151-37C		10	•		•
19G x 90 cm (35")	closed	3	001151-37A		10	•		•
19G x 90 cm (35")	closed	3	021151-37A	021163-37A	10			•
19G x 90 cm (35")	open		031151-37A		10			•

EpiLong Soft Sono

Fully Echogenic Soft Catheter Sets for Epidural Anesthesia

- 1 Cornerstone Reflectors
- 2 Precision-ground **Metal** Stylet
- 3 Detachable Plastic Wings
- 4 Soft Catheter
- 5 Integrated Metal Helical Coil
- 6 Closed Tip and 6 Lateral Openings

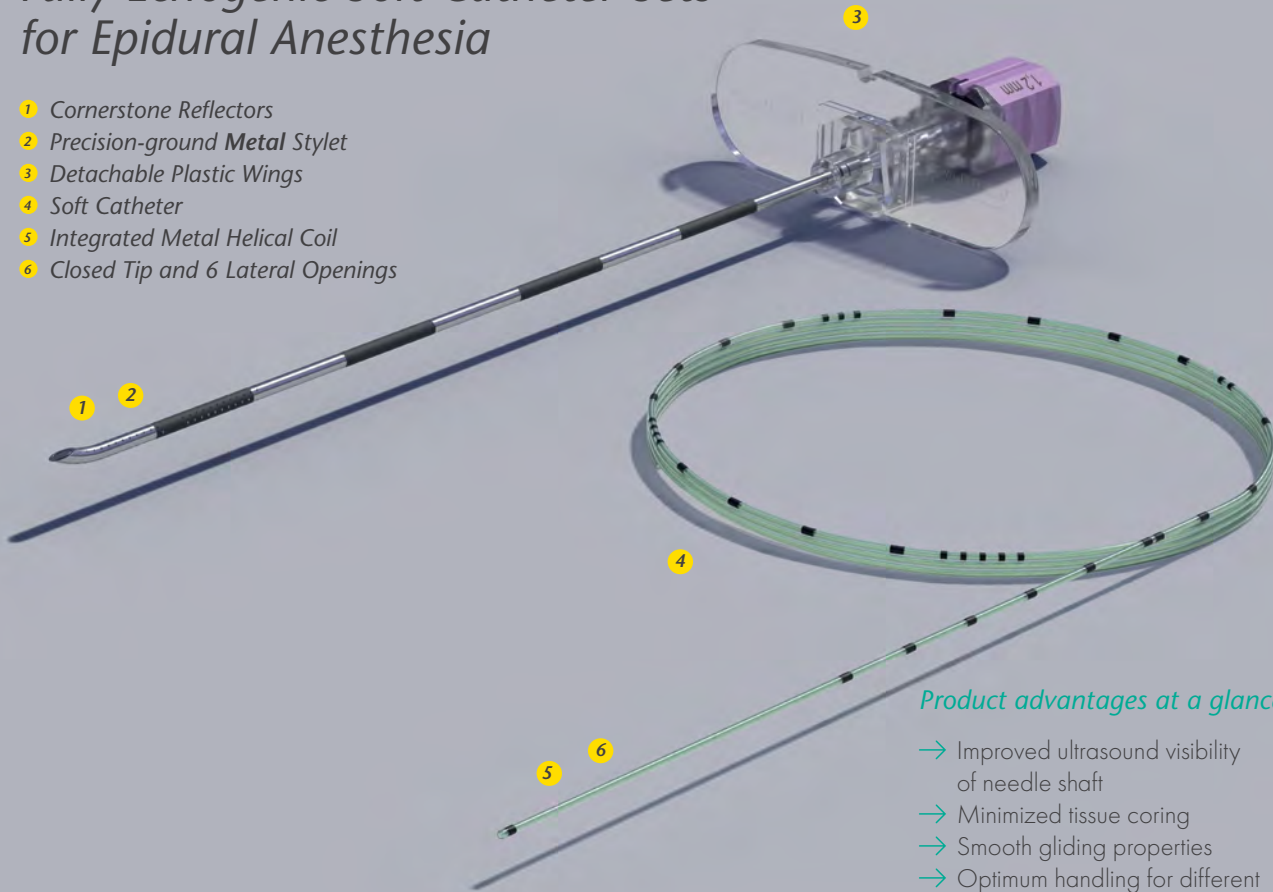

Product advantages at a glance:

- Improved ultrasound visibility of needle shaft
- Minimized tissue coring
- Smooth gliding properties
- Optimum handling for different gripping techniques
- Kink resistant

Description	Catheter	Item no.	PU	FixoLong	Filter	Clamping Adapter	LOR 10 ml
• 18G x 50 mm (2")	20G x 90 cm (35")	0631187-51	10	•	•	•	•
18G x 90 mm (3 1/2")	20G x 90 cm (35")	0431187-51	10	•	•	•	•
17G x 90 mm (3 1/2")	19G x 90 cm (35")	0431187-48	10	•	•	•	•

• Small patient product

EpiLong Sets

Catheters for Epidural Anesthesia

- 1 Precision-ground Stylet
- 2 Detachable Plastic Wings
- 3 Polyamide Catheter with Closed Tip and 3 Lateral Openings

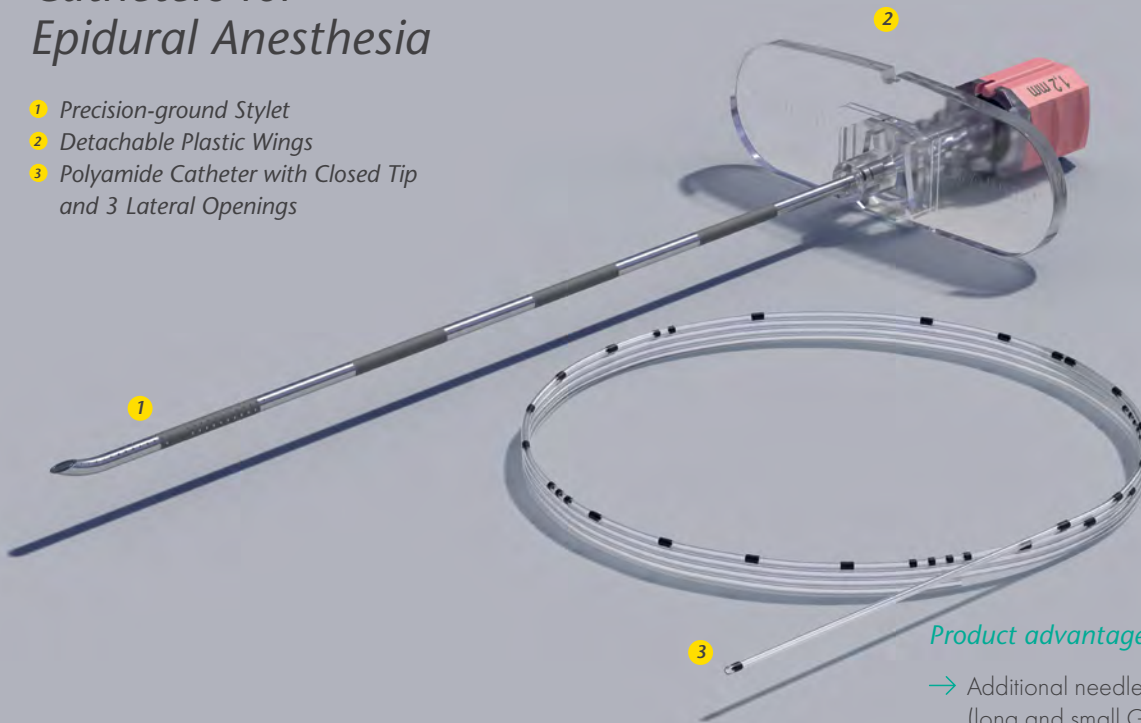

Product advantages at a glance:

- Additional needle stability (long and small G-size needles)
- Minimized tissue coring and improved gliding characteristics
- Correspondingly lower cost (plastic stylet)
- Optimum handling for different gripping techniques
- Ideal balance of stability and softness
- Easy to advance and remove
- MR unsafe

Description	Item no.	PU
EpiLong Set 18G x 3 1/2" (90 mm) Tuohy needle with 1 cm graduation, plastic stylet and wings, EpiLong 20G x 35" (90 cm) catheter with closed tip and 3 lateral openings, clamping adapter, Filter 0.2µm	0321152-51	10
EpiLong Set 19G x 1 3/4" (45 mm) • Tuohy needle with graduation, metal stylet and wings, EpiLong 23G x 20" (50 cm) catheter with closed tip and 3 lateral openings, clamping adapter, LOR syringe LUER 10ml Lock (plastic), Filter 0.2µm	0131153-50	10
EpiLong Set 19G x 2" (50 mm) • Tuohy needle with graduation, metal stylet and wings, EpiLong Echo 21G x 20" (50 cm) catheter with closed tip and 3 lateral openings, clamping adapter, LOR syringe LUER 10ml Lock (plastic), Filter 0.2µm	0131153-51	10
EpiLong Set 21G x 1 1/2" (40 mm) • Tuohy NanoLine needle with graduation, metal stylet and wings, EpiLong Echo 25G x 20" (50 cm) catheter with closed tip and 3 lateral openings, steel stylet, clamping adapter, LOR syringe LUER 10ml Lock (plastic), Filter 0.2µm	0131156-51	10

- Small patient product

StimuLong Sono Tsui Set

Echogenic, Stimulating CTN Caudal Anesthesia System with Echogenic Needle

- 1 Cornerstone Reflectors
- 2 Echogenic Plastic Catheter
Supported by a Helical Coil
- 3 Rounded Stimulating Catheter Tip
- 4 Steel Stylet

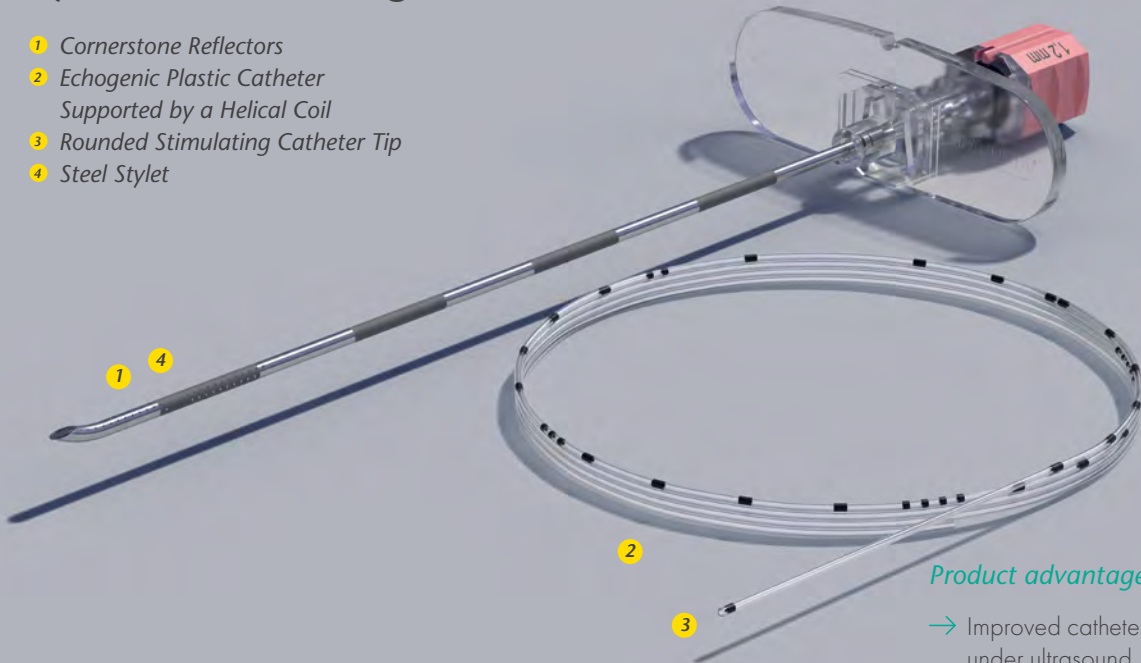

Product advantages at a glance:

- Improved catheter visibility under ultrasound
- Catheter remains sterile during the whole procedure
- More precise catheter tip positioning through stimulation option
- Atraumatic catheter tip
- Removable stylet adds stability and improves catheter threadability and manoeuvrability
- Improved ultrasound visibility of needle shaft

Description	Item no.	PU
<ul style="list-style-type: none"> • StimuLong Sono Tsui Catheter-through-Needle PNB Catheter System 18G x 2" (50 mm) TuohySono needle with 1 cm graduation, metal stylet and wings, 60 cm injection tubing, Sideport Valve with injection tubing, StimuLong Sono 20G x 35" (90 cm) echogenic, stimulating catheter with open tip, catheter container with introducer aid, 30 cm graduation, helical coil, electrically conductive stylet, steel stylet with guidance, clamping adapter with stimulation connection (2), 60 cm connecting cable (2), LOR syringe LUER 10 ml Lock (plastic), FixoCath catheter fixation device 	531156-35U	10
<ul style="list-style-type: none"> • StimuLong Sono Tsui Catheter-through-Needle PNB Catheter System 18G x 4" (100 mm) TuohySono needle with 1 cm graduation, metal stylet and wings, 60 cm injection tubing, Sideport Valve with injection tubing, StimuLong Sono 20G x 35" (90 cm) echogenic stimulating catheter with open tip, catheter container with introducer aid, 30 cm graduation, helical coil, electrically conductive stylet, steel stylet with guidance, clamping adapter with stimulation connection (2), 60 cm connecting cable (2), LOR syringe LUER 10 ml Lock (plastic), FixoCath catheter fixation device [10/box] 	521156-35U	10

• Small patient product

A series of horizontal dashed lines for writing notes.

EPI SPIN LOCK & SPROTTE® EPIDURAL ANESTHESIA'S FAVORITE POWER COUPLE

EpiSpin Lock offers smooth and stable spinal puncture while minimizing post-spinal headache with the original SPROTTE® atraumatic needle.

 MADE IN GERMANY



EpiSpin Lock Combined Spinal-Epidural Anesthesia (CSE)

- 1 Unique Locking System
- SPROTTE locks in place through the back-eye of the Tuohy, removing the need for a third hand
- When Spinal Anesthesia is complete, EpiSpin Lock rotates 90° and easily disconnects from the Tuohy in preparation for Epidural Anesthesia

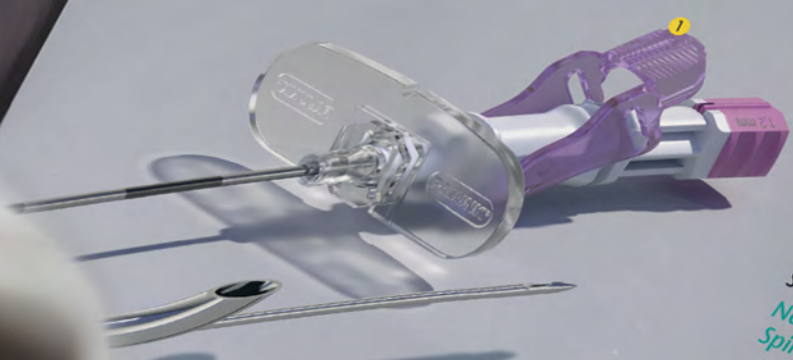

SPROTTE® Needles for Atraumatic Spinal Anesthesia

- 2 The ogive shaped tip significantly reduces the risk of PDPH.^{1,2}
- The rounded edges of the lateral eye minimize trauma and provide excellent tactile feedback
- Clear, magnifying needle hub allows for easy visualization of CSF

Available in
 ISO
 L268
 ISO
 NRIF

EXAMPLES & AN ONLINE DEMO NOW!
www.pajunkusa.com



¹ Walker M. C., Mitchell G. L., Suter D. R., Fennema-Notestine C., Walker-Kornblum A., Robinson C., et al. Comparison of Post-Spinal Headache Rates in Spinal Anesthesia Using Tuohy Needles with and without a Lateral Eye. *Spinal Anesthesia*. 2010; 25(1): 1-6.
² Wang K., Yang L., Wang S., Wang F., Han J., Du C., Guo Y. H., et al. Comparison of Complications and Post-Spinal Headache Rates in Spinal Anesthesia Using Tuohy Needles with and without a Lateral Eye. *Spinal Anesthesia*. 2010; 25(1): 1-6.

30
 43
 15
 16

Combined Spinal-Epidural Anesthesia

Unique Needle Systems for CSE



EpiSpin Lock Needles

Unique CSE Needle Systems with Locking Mechanism

- 1 Unique Locking System
- 2 Back-Eye Opening
- 3 Atraumatic Tip Design
- 4 Magnifying Hub
- 5 Outlet Marking
- 6 Precision-ground Metal Stylet

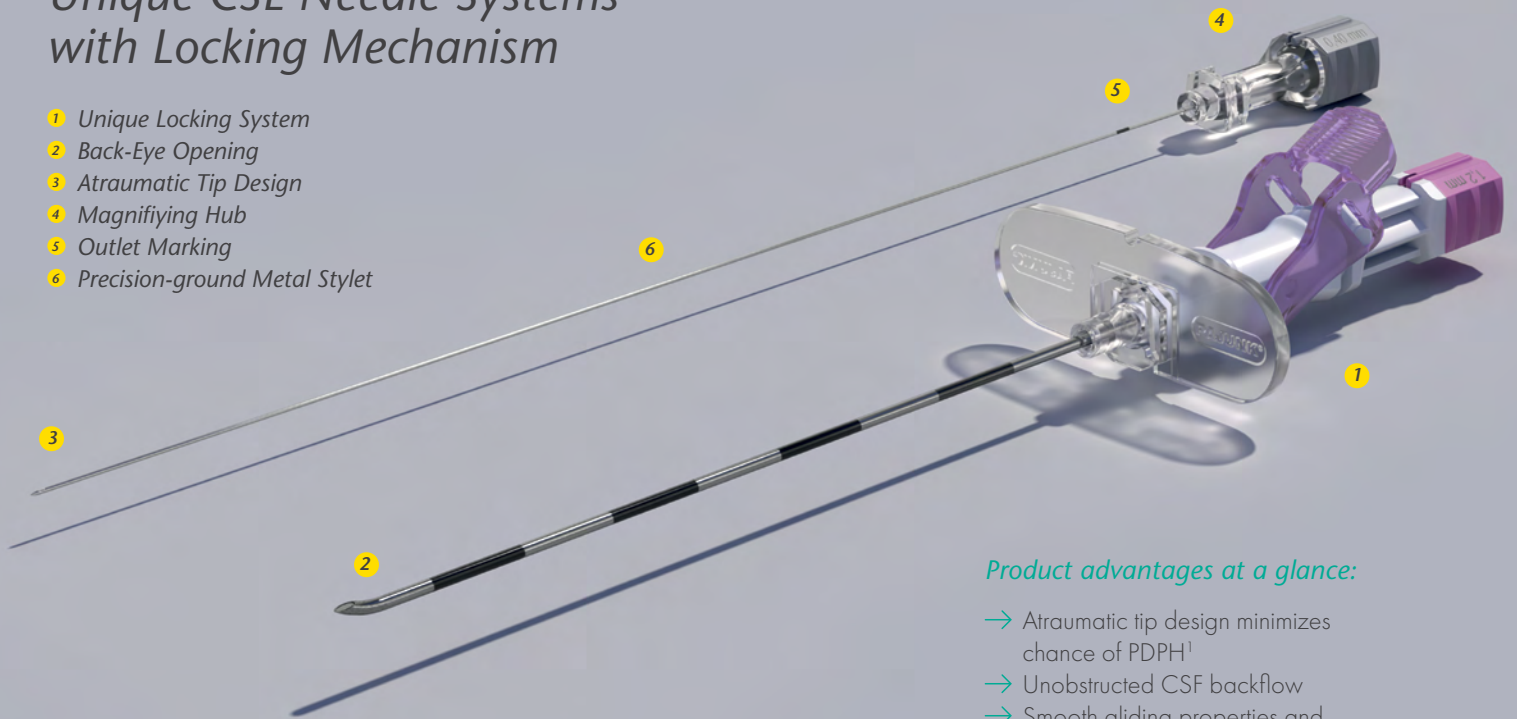

Product advantages at a glance:

- Atraumatic tip design minimizes chance of PDPH¹
- Unobstructed CSF backflow
- Smooth gliding properties and improved tactile feedback
- Minimized tissue coring
- Optimum handling for different gripping techniques
- Easy fixation of spinal needle

Description	SPROTTE®	Item no.	PU
18G x 90mm (3 1/2")	27G	0011351-30	10
18G x 90mm (3 1/2")	25G	0011351-18	10
18G x 135mm (5 3/8")	27G	0011351-26	10
17G x 90mm (3 1/2")	25G	0011351-20	10
17G x 135mm (5 3/8")	25G	0011351-25	10

Catheters see page 13

EpiSpin II Safety

Unique CSE Catheter Sets with Fixation Device

- 1 Fixation Device
- 2 Back-Eye Design
- 3 Atraumatic Tip Design
- 4 Magnifying Hub
- 5 Outlet Marking
- 6 Precision-ground Metal Stylet
- 7 Catheter with Closed Tip and 3 Lateral Openings

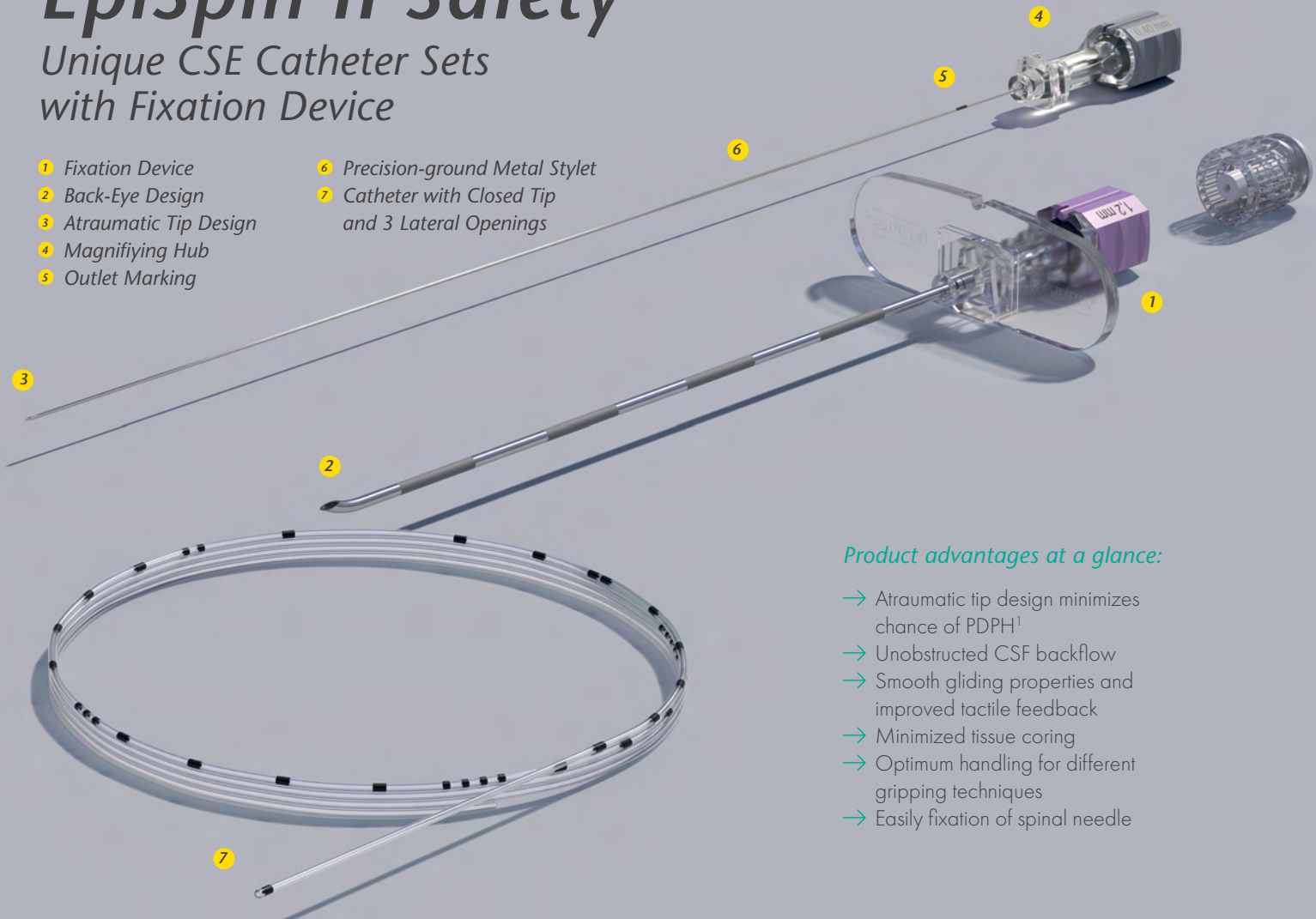

Product advantages at a glance:

- Atraumatic tip design minimizes chance of PDPH¹
- Unobstructed CSF backflow
- Smooth gliding properties and improved tactile feedback
- Minimized tissue coring
- Optimum handling for different gripping techniques
- Easily fixation of spinal needle

Description	Catheter	Sprotte	Item no.	NRFit® Item no.	PU	Filter	Clamping Adapter	LOR 10 ml
18G x 90 mm (3 1/2")	20G x 90 mm (35")	27G	0021451-30	1022461-30	10	•	•	•
18G x 90 mm (3 1/2")	20G x 90 mm (35")	25G	0021451-18	1022461-18	10	•	•	•

¹ Cesari, M. et al. Sprotte needle for intrathecal anaesthesia for Caesarean section: incidence of postdural puncture headache. Anaesthesia 1990; 45: 646 -658

SonoPlex® II & E-Cath® REGIONAL ANESTHESIA'S FAVORITE POWER COUPLE

Our Product Power Couple is the perfect solution for all of your **Single Shot** or **Continuous Nerve Blocks**, offering great visibility, ease-of-use, and the versatility you need.

 **MADE IN GERMANY**



SonoPlex II/SonoBlock II The Standard for Ultrasound-Guided Single-Shot Nerve Blocks

- Cornerstone Reflectors and NanoLine® coating increase shaft and tip echogenicity
- Newly Optimized Hub
 - Color-coded hub for easy size identification
 - Fixed injection tubing
 - Removable stimulation cord (SonoPlex II)



*Excellent visibility
irrespective of
the insertion angle*

E-Cath/E-Cath Plus Nerve Block Catheter Placement as Easy as a Single-Shot

- Catheter over Needle (CON) technique reduces leakage, migration, and kinking
- Cornerstone Reflectors increase visibility during placement
- New lengths in 100mm and 150mm

Products are available in customizable procedural trays

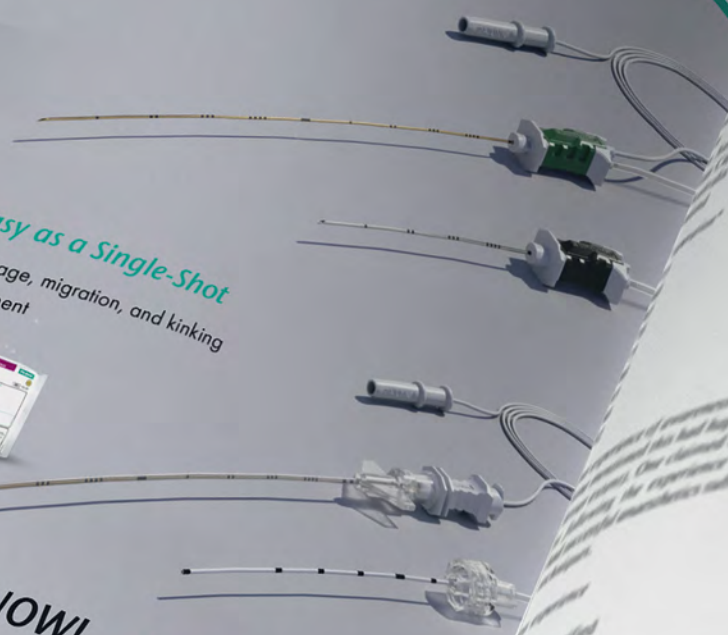

OUR TRIAL SAMPLES NOW!
www.pajunkusa.com



30
43
15
16

Nerve Blocks

*Single Shot and Continuous Products for
Ultrasound and Dual-Guided Nerve Blocks*



SonoPlex® II

Echogenic, Stimulating Single Shot Nerve Block Needles

- 1 Echogenic Needle Tip
- 2 Cornerstone Reflectors
- 3 NanoLine® Coating
- 4 Removable Stimulation Cable
- 5 Bevel Configurations (Facet, Facet S, SPROTTE®)
- 6 Non-Removable Injection Tubing
- 7 Color-Coded Needle Hub

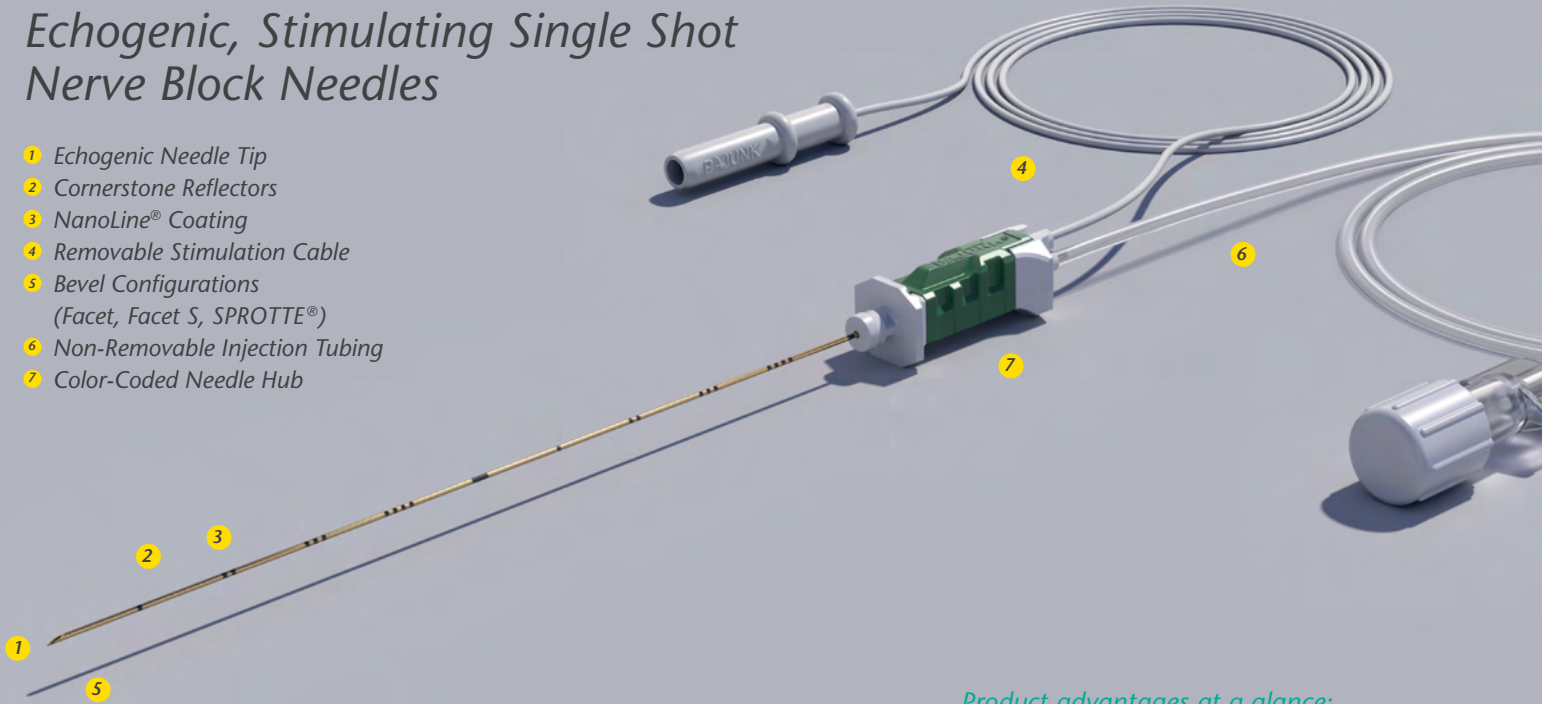

Product advantages at a glance:

- #1 echogenic nerve block needle globally
- Reliable needle visualization at any angle
- Optimized ultrasound visibility of needle shaft
- Smooth gliding properties
- Stimulating (Dual-Guidance)

SonoPlex II with Facet Tip	Item no.	NRFit® Item no.	PU	SonoPlex II with Facet S Tip	Item no.	NRFit Item no.	PU
• 24G x 30 mm (1 1/5")	001285-75	001265-75	10	• 25G x 50 mm (2")	001287-81	001267-81	10
• 22G x 40 mm (1 5/8")	001285-70	001265-70	10	• 24G x 40 mm (1 5/8")		001267-78	10
• 22G x 50 mm (2")	001285-74	001265-74	10	• 24G x 50 mm (2")	001287-85	001267-85	10
22G x 80 mm (3 1/5")	001285-71	001265-71	10	• 22G x 40 mm (1 5/8")	001287-70	001267-70	10
21G x 100 mm (4")	001285-77	001265-77	10	• 22G x 50 mm (2")	001287-74	001267-74	10
20G x 100 mm (4")	001285-95		10	22G x 80 mm (3 1/5")	001287-71	001267-71	10
20G x 120 mm (4 3/4")	001285-72	001265-72	10	21G x 80 mm (3 1/5")	001287-88	001267-88	10
20G x 150 mm (6")	001285-76	001265-76	10	21G x 100 mm (4")	001287-77	001267-77	10
				20G x 100 mm (4")	001287-95	001267-95	10
				20G x 120 mm (4 3/4")	001287-72	001267-72	10
				20G x 150 mm (6")	001287-76	001267-76	10
SonoPlex II with Sprotte Tip	Item no.	NRFit Item no.	PU				
• 22G x 50 mm (2")	001285-31G	001267-31G	10				
22G x 90 mm (3 1/2")	001285-31J	001265-31J	10				

• Small patient product

SonoBlock II

Echogenic, Non-stimulating Single Shot Nerve Block Needles

- 1 Echogenic Needle Tip
- 2 Cornerstone Reflectors
- 3 NanoLine Coating
- 4 Bevel Configurations (Facet, Facet S)
- 5 Non-Removable Injection Tubing
- 6 Color-Coded Needle Hub

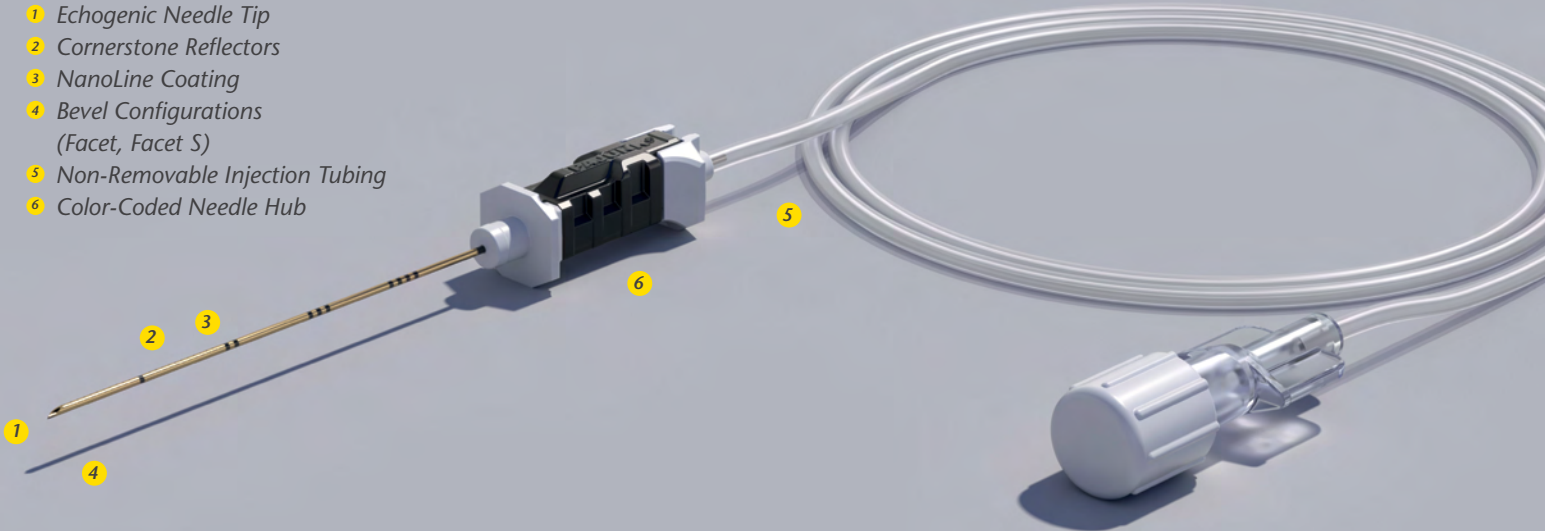

Product advantages at a glance:

- #1 echogenic nerve block needle globally
- Reliable needle visualization at any angle
- Optimized ultrasound visibility of needle shaft
- Smooth gliding properties
- Non-stimulating (ultrasound-guidance only)

SonoBlock II with Facet Tip	Item no.	NRFit Item no.	PU	SonoBlock II with Facet S Tip	Item no.	NRFit Item no.	PU
• 22G x 50 mm (2")	001280-74	001260-74	10	• 22G x 40mm (1 5/8")	001281-70		10
22G x 80 mm (3 1/5")	001280-71	001260-71	10	• 22G x 50mm (2")	001281-74		10
20G x 120 mm (4 3/4")	001280-72		10	22G x 80mm (3 1/5")	001281-71		10
21G x 100 mm (4")	001280-77		10	21G x 100mm (4")	001281-77		10
20G x 100 mm (4")	001280-95		10	20G x 100mm (4")	001281-95		10
				20G x 120mm (4 3/4")	001281-72		10

• Small patient product

SonoTAP[®] II

Echogenic, Non-stimulating Single Shot Fascial Plane Block Needles

- 1 Echogenic Needle Tip
- 2 Cornerstone Reflectors
- 3 Facet Tip
- 4 Non-Removable Injection Tubing
- 5 Color-Coded Needle Hub

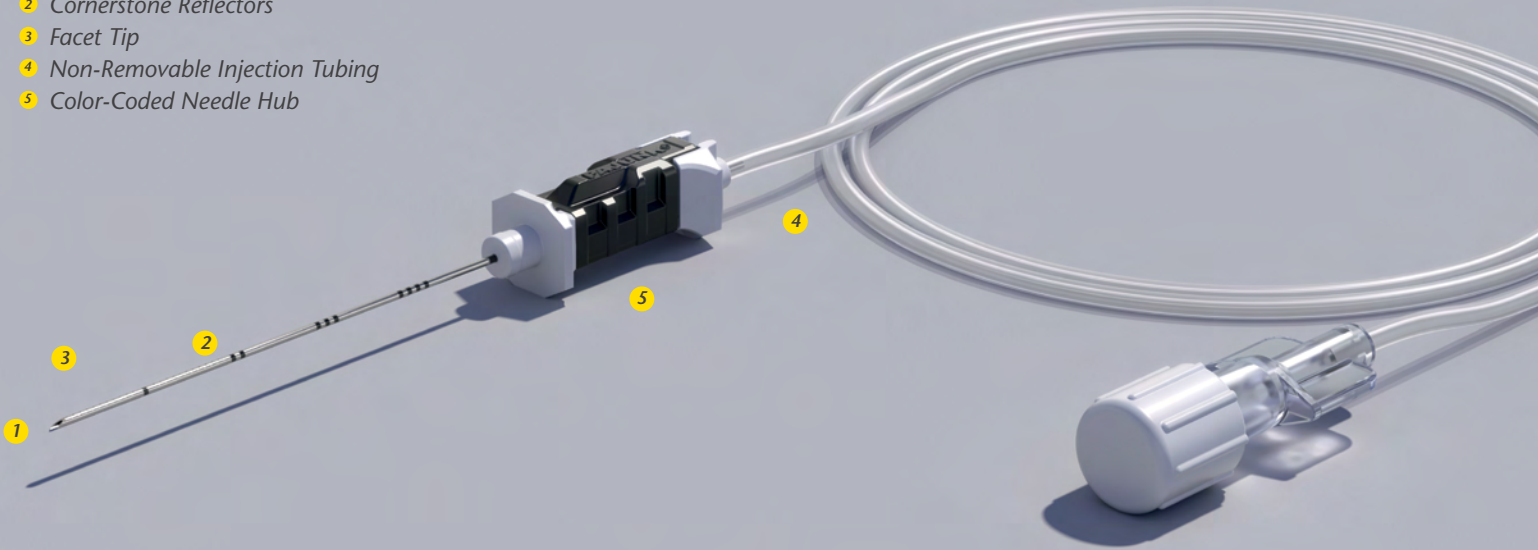

Product advantages at a glance:

- Reliable needle visualization at any angle
- Optimized ultrasound visibility of needle shaft
- Non-stimulating (ultrasound-guidance only)

Description	Item no.	NRFit [®] Item no.	PU
• 24G x 40mm (1 5/8")	1285-3Y040	1265-3Y040	10
• 24G x 50mm (2")	1285-3Y050	1265-3Y040	10
• 22G x 50mm (2")	1285-3E050	1265-3E050	10
22G x 80mm (3 1/5")	1285-3E080	1265-3E080	10
21G x 110mm (4")	1285-3F110	1265-3F110	10
21G x 150mm (6")	1285-3F150	1265-3F150	10

- Small patient product

TuohySono

Echogenic, Non-stimulating Single Shot Plane Block Needles

- 1 Echogenic Needle Tip
- 2 Cornerstone Reflectors
- 3 Depth Markings
- 4 Precision-ground Metal Stylet
- 5 Detachable Plastic Wings

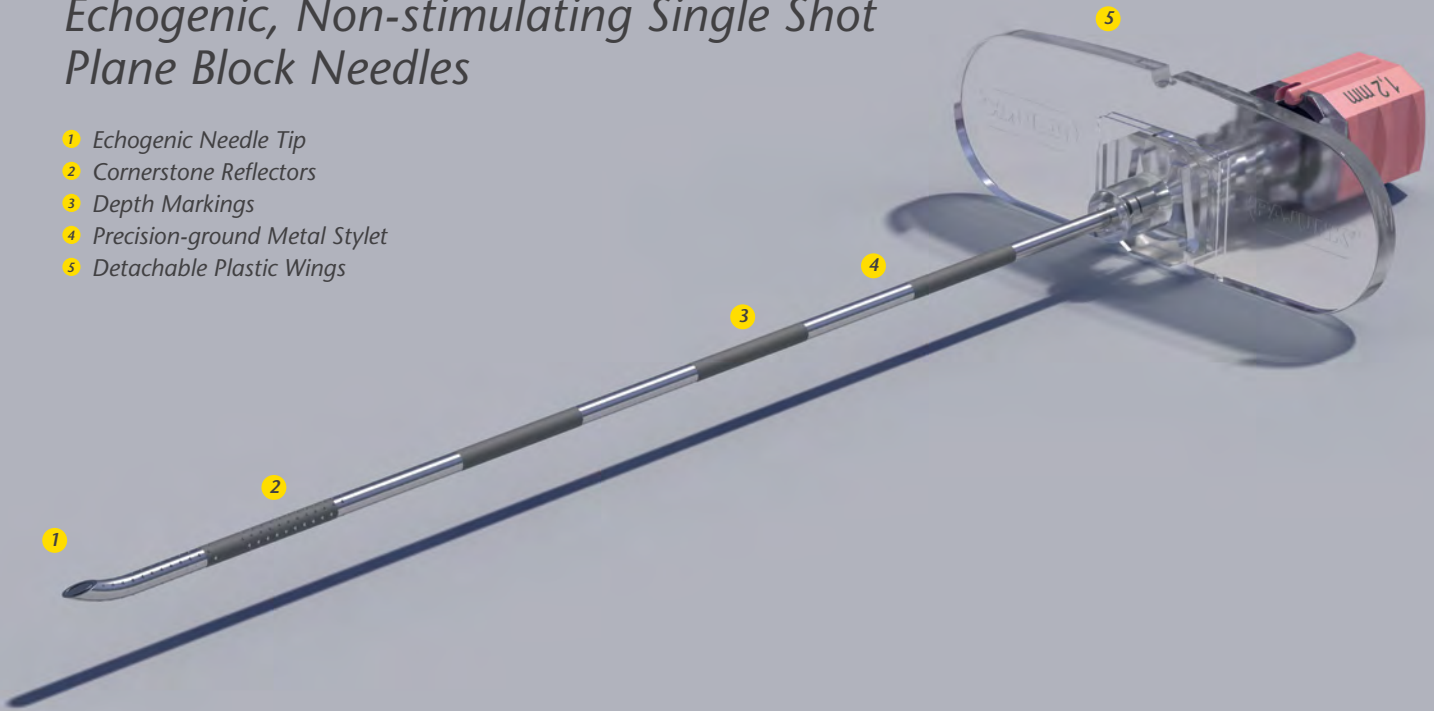

Product advantages at a glance:

- Reliable needle visualization at any angle
- Optimized ultrasound visibility of needle shaft
- Non-stimulating (ultrasound-guidance only)

Description	Item no.	PU
• 22G x 50 mm (2")	1085-4E050	25
22G x 90 mm (3 1/2")	1085-4E090	25
22G x 120 mm (4 3/4")	1085-4E120	10
21G x 90 mm (3 1/2")	1085-4F090	25
21G x 120 mm (4 3/4")	1085-4F120	10
• 18G x 50 mm (2")	1085-4K050	25
18G x 90 mm (3 1/2")	1085-4K090	25
18G x 120 mm (4 3/4")	1085-4K120	10
17G x 90 mm (3 1/2")	1085-4M090	25

- Small patient product

UniPlex®

Stimulating Single Shot Nerve Block Needles

- 1 Echogenic Needle Tip
- 2 NanoLine® Coating
- 3 Stimulation Cable
- 4 Bevel Configurations (Facet, Facet S, SPROTTE®)

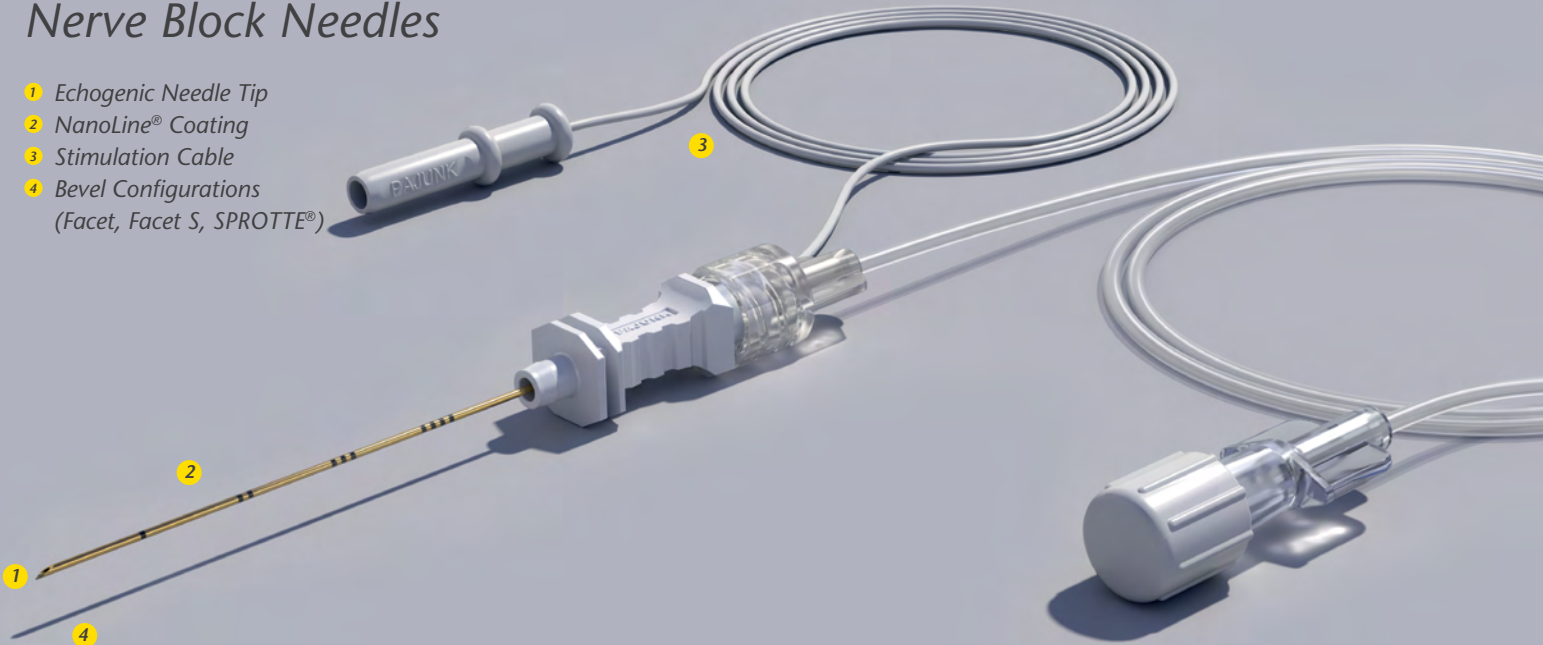

Product advantages at a glance:

- Smooth gliding properties
- Stimulating

UniPlex with Facet Tip	Item no.	NRFit® Item no.*	PU	UniPlex with Facet S Tip	Item no.	NRFit Item no.*	PU
• 25G x 35 mm (1 1/3")	001156-80	001246-80	10	• 25G x 35 mm (1 1/3")	001157-80	001247-80	10
• 25G x 50 mm (2")	001156-81	001246-81	10	• 25G x 50 mm (2")		001247-81	10
• 25G x 80 mm (3 1/5")	001156-86		10	• 24G x 25 mm (1")	001157-75	001247-75**	10
• 24G x 25 mm (1")	001156-75	001246-75**	10	• 24G x 50 mm (2")	001157-81	001247-85	10
• 24G x 50 mm (2")	001156-85	001246-85	10	• 22G x 40 mm (1 5/8")	001157-70		10
• 22G x 40 mm (1 5/8")	001156-70	001246-70	10	• 22G x 50 mm (2")	001157-74	001247-74	10
• 22G x 50 mm (2")	001156-74	001246-74	10	• 22G x 80 mm (3 1/5")	001157-71	001247-71	10
• 22G x 80 mm (3 1/5")	001156-71	001246-71	10	• 22G x 100 mm (4")		001247-84	10
• 22G x 100 mm (4")	001156-84	001246-84	10	• 21G x 100 mm (4")	001157-77	001247-77	10
• 22G x 120 mm (4 3/4")	001156-82	001246-82	10	• 20G x 150 mm (6")	001157-76	001247-76	10
• 21G x 100 mm (4")	001156-77	001246-77	10				
• 20G x 120 mm (4 3/4")	001156-72	001246-72	10	UniPlex with Sprotte Tip	Item no.	NRFit Item no.*	PU
• 20G x 150 mm (6")	001156-76	001246-76	10	• 24G x 40 mm (1 5/8")	001156-30G		10
				• 22G x 50 mm (2")	001156-31G	001246-31G	10
				• 22G x 70 mm (2 3/4")	001156-31H	001246-31H	10
				• 22G x 90 mm (3 1/2")	001156-31J	001246-31J	10
				• 22G x 150 mm (6")	001156-28L	001246-28L	10

• Small patient product

* with UniPlex II – 2nd generation needle

** 24G x 30 mm (1 1/5")

E-Cath[®]

Echogenic Catheter-Over-Needle Systems

- 1 Catheter-Over-Needle Technique
- 2 Cornerstone Reflectors
- 3 Facet Tip
- 4 NanoLine Coating
- 5 Self-Priming System
- 6 Soft Open Tip
- 7 Stimulation Cable

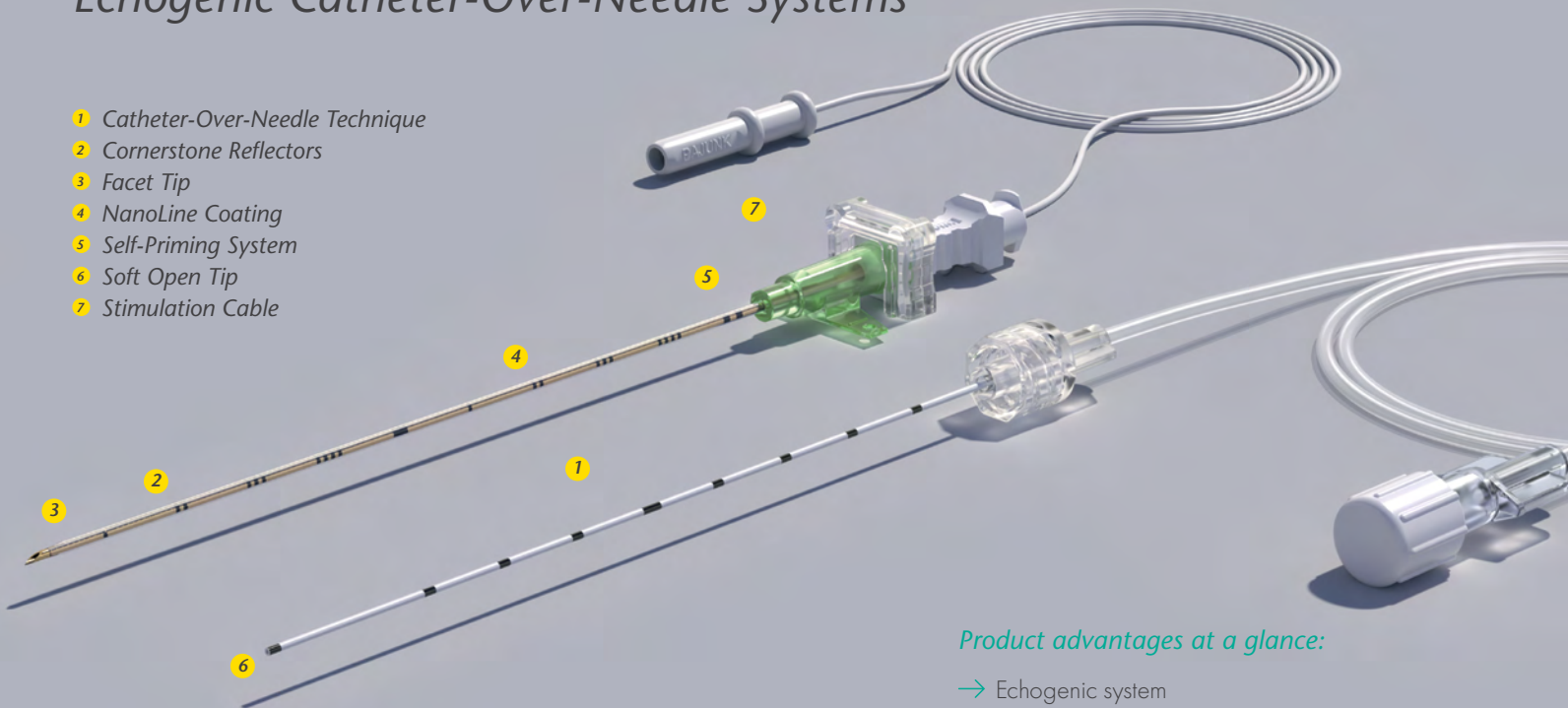

Product advantages at a glance:

- Echogenic system
- Soft open tip catheter with additional 360° lateral opening
- Stimulating

Indwelling catheter (working length)	SonoPlex [®] Needle	E-Catheter	Item no.*	NRFit Item no.**	PU
18G x 51 mm (2")	21G x 68 mm (2 2/3")	20G	201285-40E	201165-40E	10
18G x 75 mm (3")	21G x 94 mm (3 2/3")	20G	211285-40E	211165-40E	10
18G x 83 mm (3 1/4")	21G x 101 mm (4")	20G	241285-40E	241165-40E	10
18G x 100 mm (4")	21G x 118 mm (4 3/4")	20G	261285-40E		10
18G x 130 mm (5 2/5")	21G x 150 mm (6")	20G	251285-40E	251165-40E	10
18G x 150 mm (6")	21G x 168 mm (6 3/5")	20G	271285-40E		10

* with FixoCath ** with SonoPlex II – 2nd generation needle and Filter

E-Cath® Plus

Echogenic Catheter-Over-Needle Systems with Extended E-Catheter Tip

- 1 Catheter-Over-Needle Technique
- 2 Cornerstone Reflectors
- 3 Facet Tip
- 4 NanoLine® Coating
- 5 Self-Priming System
- 6 Three Lateral Openings
- 7 Stimulation Cable
- 8 Extended 15 mm Tip

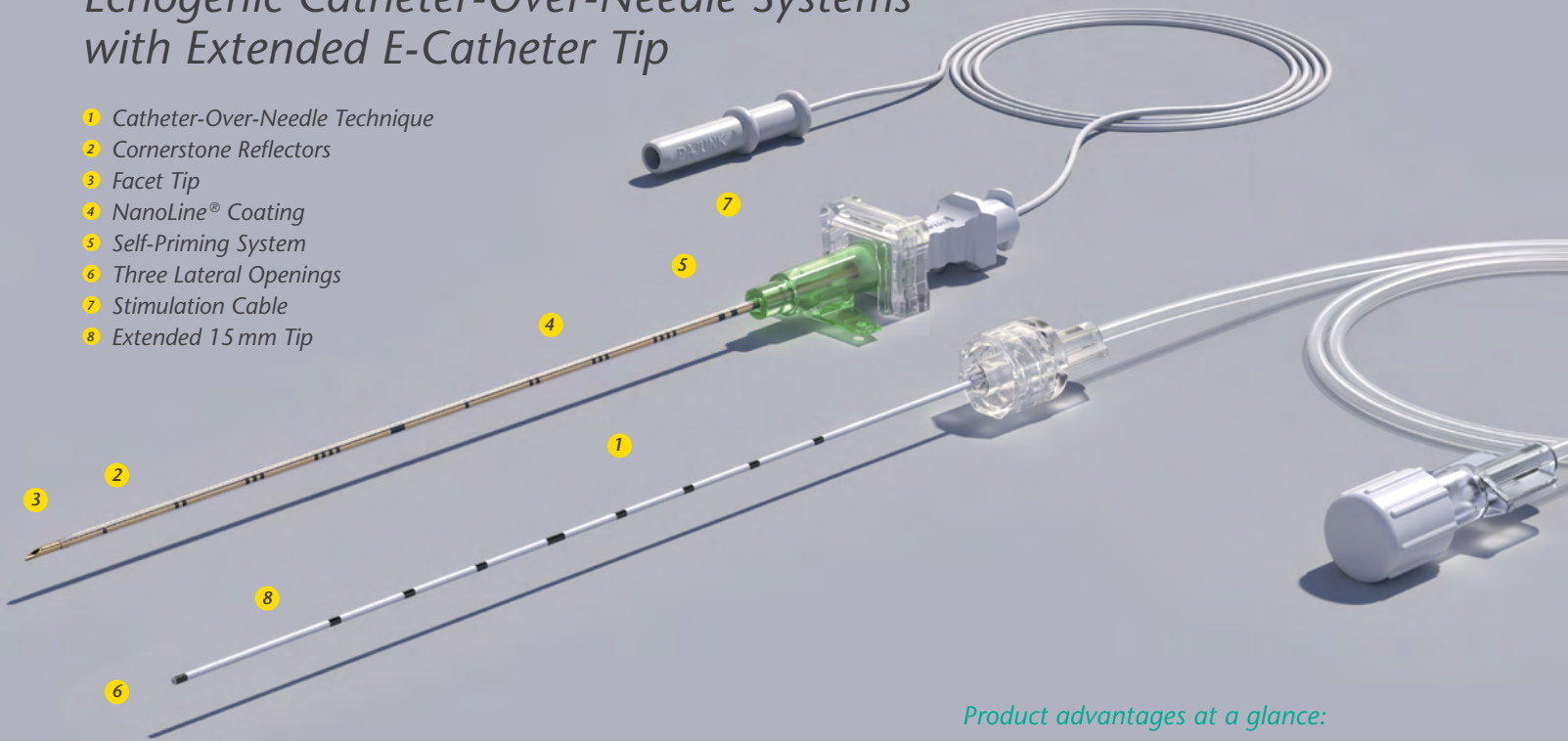

Product advantages at a glance:

- Echogenic system
- Closed tip and 3 lateral openings
- Stimulating

Indwelling catheter (working length)	SonoPlex Needle	E-Catheter	Item no.*	NRFit® Item no.**	PU
18G x 51 mm (2")	21G x 68 mm (2 2/3")	20G	201285-41E	201165-41E	10
18G x 75 mm (3")	21G x 94 mm (3 2/3")	20G	211285-41E	211165-41E	10
18G x 83 mm (3 1/4")	21G x 101 mm (4")	20G	241285-41E	241165-41E	10
18G x 100 mm (4")	21G x 118 mm (4 3/4")	20G	261285-41E		10
18G x 130 mm (5 2/5")	21G x 150 mm (6")	20G	251285-41E	251165-41E	10
18G x 150 mm (6")	21G x 168 mm (6 3/5")	20G	271285-41E		10

* with FixoCath ** with SonoPlex II – 2nd generation needle and Filter

E-Cath Stim

Echogenic, Stimulating Catheter-Over-Needle CNB Systems

- 1 Catheter-Over-Needle Technique
- 2 Cornerstone Reflectors
- 3 Facet Tip
- 4 NanoLine Coating
- 5 Self-Priming System
- 6 Stimulating Open Tip
- 7 Stimulation Cable

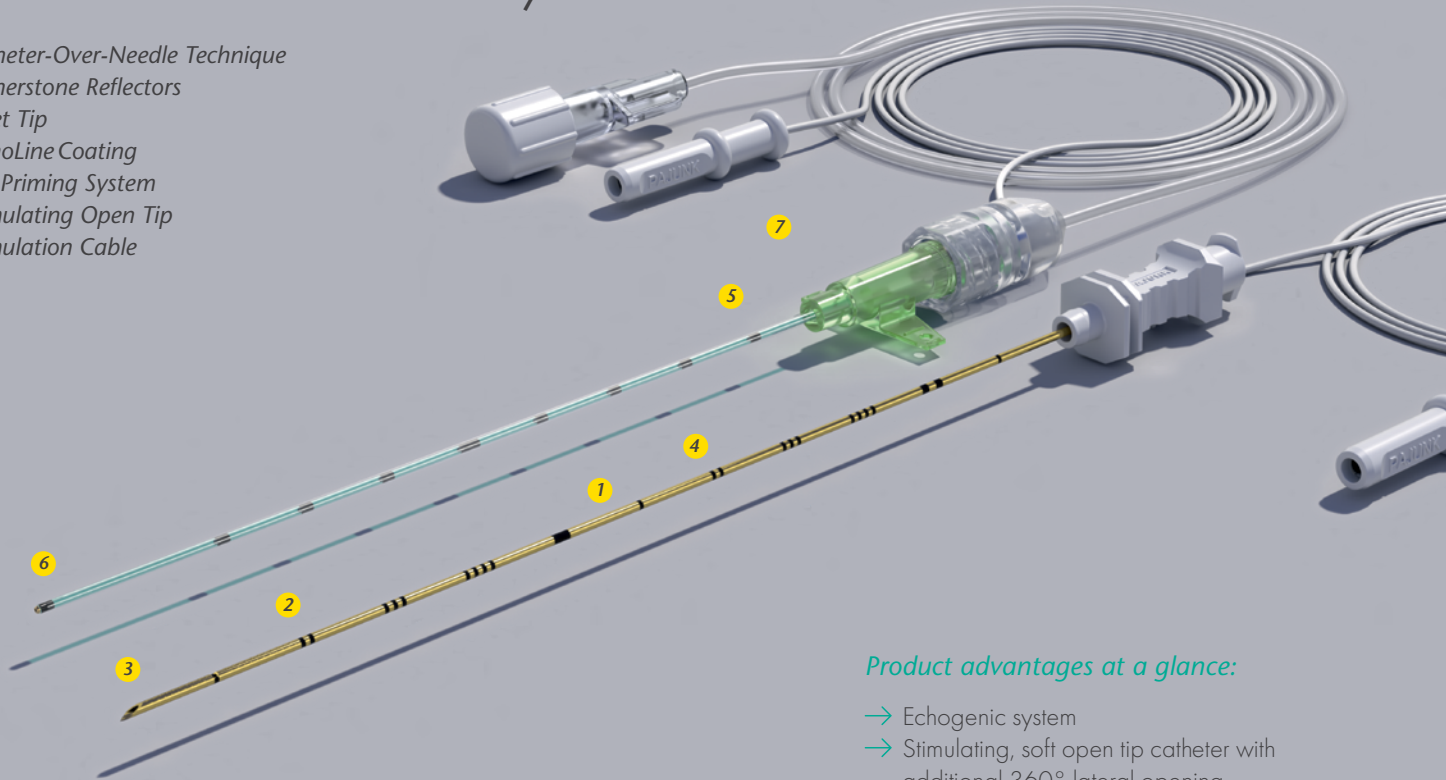

Product advantages at a glance:

- Echogenic system
- Stimulating, soft open tip catheter with additional 360° lateral opening
- Precise conductivity and stimulation capability due to gold-plated catheter tip

Indwelling catheter (working length)	SonoPlex® Needle	E-Catheter Stim	Item no.	NRFit Item no.*	PU	FixoCath
18G x 51 mm (2")	21G x 68 mm (3 3/4")	20G	201285-42E		10	•
18G x 83 mm (3 1/4")	21G x 101 mm (4")	20G	241285-42E		10	•

* with SonoPlex II – 2nd generation needle

SonoLong Echo

Echogenic Catheter-Through-Needle Systems

- 1 Catheter with Open or Closed Tip
- 2 Depth Markings
- 3 Echogenic Needle Tip
- 4 Cornerstone Reflectors
- 5 NanoLine® Coating
- 6 Stimulation Cable
- 7 Bevel Configurations (Facet, Tuohy, SPROTTE®)

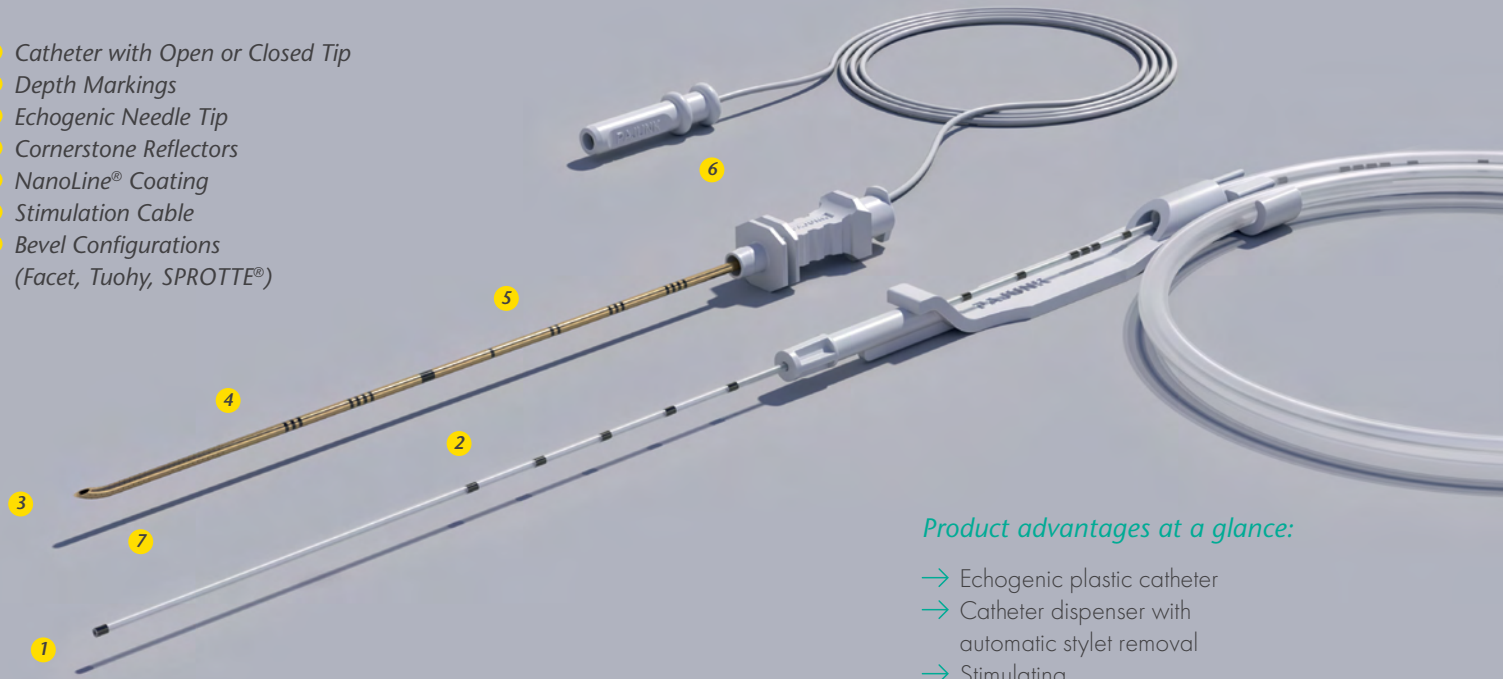

Product advantages at a glance:

- Echogenic plastic catheter
- Catheter dispenser with automatic stylet removal
- Stimulating

SonoLong Echo with Facet Tip	Catheter	Item no.	NRFit® Item no.	PU	FixoLong	Filler	Clamping Adapter
• 19G x 50 mm (2")	20G x 50 cm (20")	531185-31A	531165-31A	10	•	•	•
• 19G x 75 mm (3")	20G x 50 cm (20")	561185-31A	561165-31A	10	•	•	•
• 19G x 100 mm (4")	20G x 50 cm (20")	521185-31A	521165-31A	10	•	•	•
• 19G x 150 mm (6")	20G x 50 cm (20")	511185-31A	511165-31A	10	•	•	•

SonoLong Echo with Tuohy Tip	Catheter	Item no.	NRFit Item no.	PU	FixoLong	Filler	Clamping Adapter
• 18G x 50 mm (2")	20G x 50 cm (20")	531185-31C		10	•	•	•
• 18G x 50 mm (2")	20G x 60 cm (23")	531185-31CU*		10	•	•	•
• 18G x 75 mm (3")	20G x 50 cm (20")	561185-31C		10	•	•	•
• 18G x 100 mm (4")	20G x 50 cm (20")	521185-31C		10	•	•	•
• 18G x 100 mm (4")	20G x 60 cm (23")	521185-31CU*		10	•	•	•
• 18G x 150 mm (6")	20G x 50 cm (20")	511185-31C	511165-31C	10	•	•	•

SonoLong Echo with Sprotte Special Tip	Catheter	Item no.	NRFit Item no.	PU	FixoLong	Filler	Clamping Adapter
• 19G x 60 mm (2 1/4")	20G x 50 cm (20")	531185-31B	531165-31B	10	•	•	•
• 19G x 120 mm (4 3/4")	20G x 50 cm (20")	521185-31B	521165-31B	10	•	•	•

*closed tip and 3 lateral openings

• Small patient product

SonoLong Sono

Echogenic Catheter-Through-Needle Systems with Stainless Steel Helical Coil

- 1 Catheter with Central Opening
- 2 Stainless Steel Helical Coil
- 3 Depth Markings
- 4 Echogenic Needle Tip
- 5 Cornerstone Reflectors
- 6 NanoLine Coating
- 7 Stimulation Cable
- 8 Bevel Configurations (Facet, Tuohy, Sprotte)

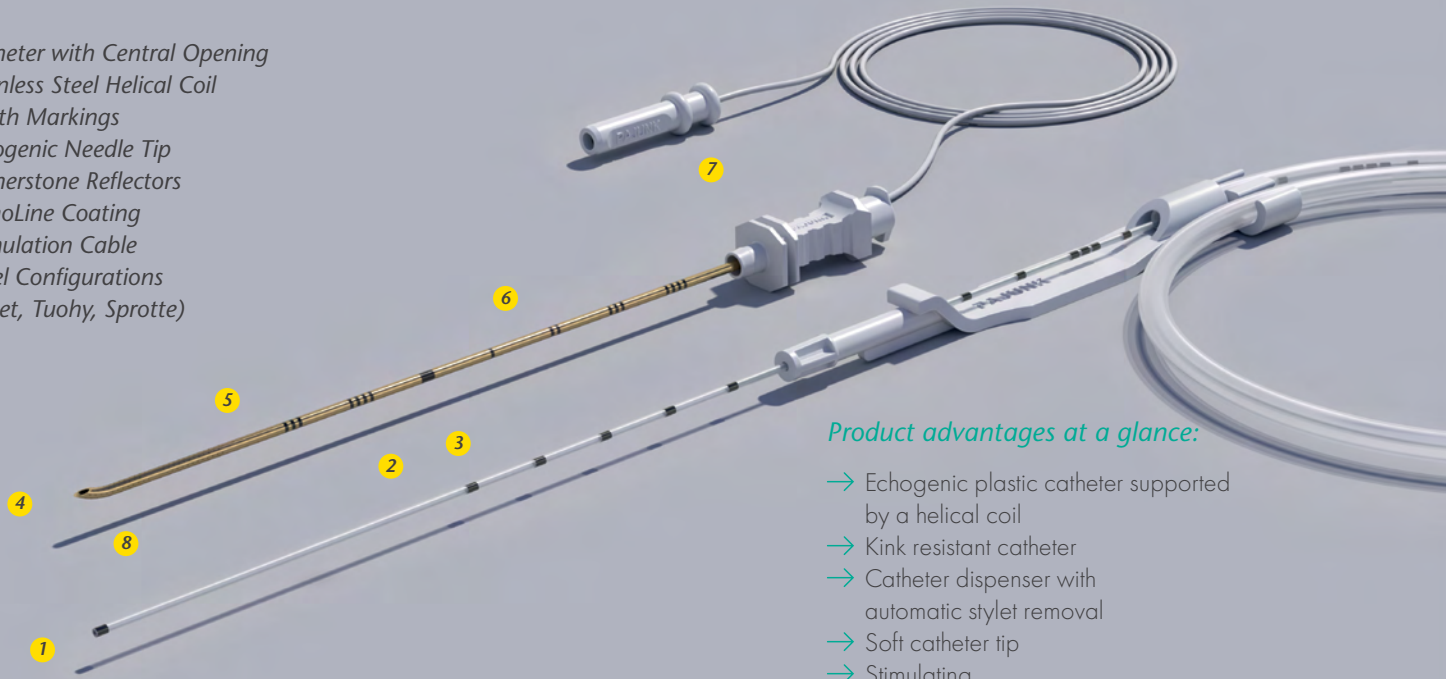

Product advantages at a glance:

- Echogenic plastic catheter supported by a helical coil
- Kink resistant catheter
- Catheter dispenser with automatic stylet removal
- Soft catheter tip
- Stimulating

SonoLong Sono with Facet Tip	Catheter	Item no.	NRFit Item no.	PU	FixoLong	Filler	Clamping Adapter
• 19G x 50 mm (2")	20G x 50 cm (20")	531187-31A	531197-31A	10	•	•	•
19G x 75 mm (3")	20G x 50 cm (20")	561187-31A	561197-31A	10	•	•	•
19G x 100 mm (4")	20G x 50 cm (20")	521187-31A	521197-31A	10	•	•	•
19G x 150 mm (6")	20G x 50 cm (20")	511187-31A	511197-31A	10	•	•	•

SonoLong Sono with Tuohy Tip	Catheter	Item no.	NRFit Item no.	PU
• 18G x 50 mm (2")	20G x 50 cm (20")	531187-31C	531197-31C	10
18G x 75 mm (3")	20G x 50 cm (20")	561187-31C		10
18G x 100 mm (4")	20G x 50 cm (20")	521187-31C		10
18G x 150 mm (6")	20G x 50 cm (20")	511187-31C		10

SonoLong Sono with Sprotte Special Tip	Catheter	Item no.	NRFit Item no.	PU
• 19G x 60 mm (2 1/4")	20G x 50 cm (20")	531187-31B	531165-31B	10
19G x 120 mm (4 3/4")	20G x 50 cm (20")	521187-31B	521165-31B	10

• Small patient product

SonoLong Curl Echo

Echogenic Specialty Catheter-Through-Needle Systems

- 1 Curled Catheter with Closed Tip and 6 Lateral Openings
- 2 Stainless Steel Helical Coil
- 3 Depth Markings
- 4 Echogenic Needle Tip
- 5 Cornerstone Reflectors
- 6 NanoLine® Coating
- 7 Stimulation Cable
- 8 Bevel Configurations (Tuohy)

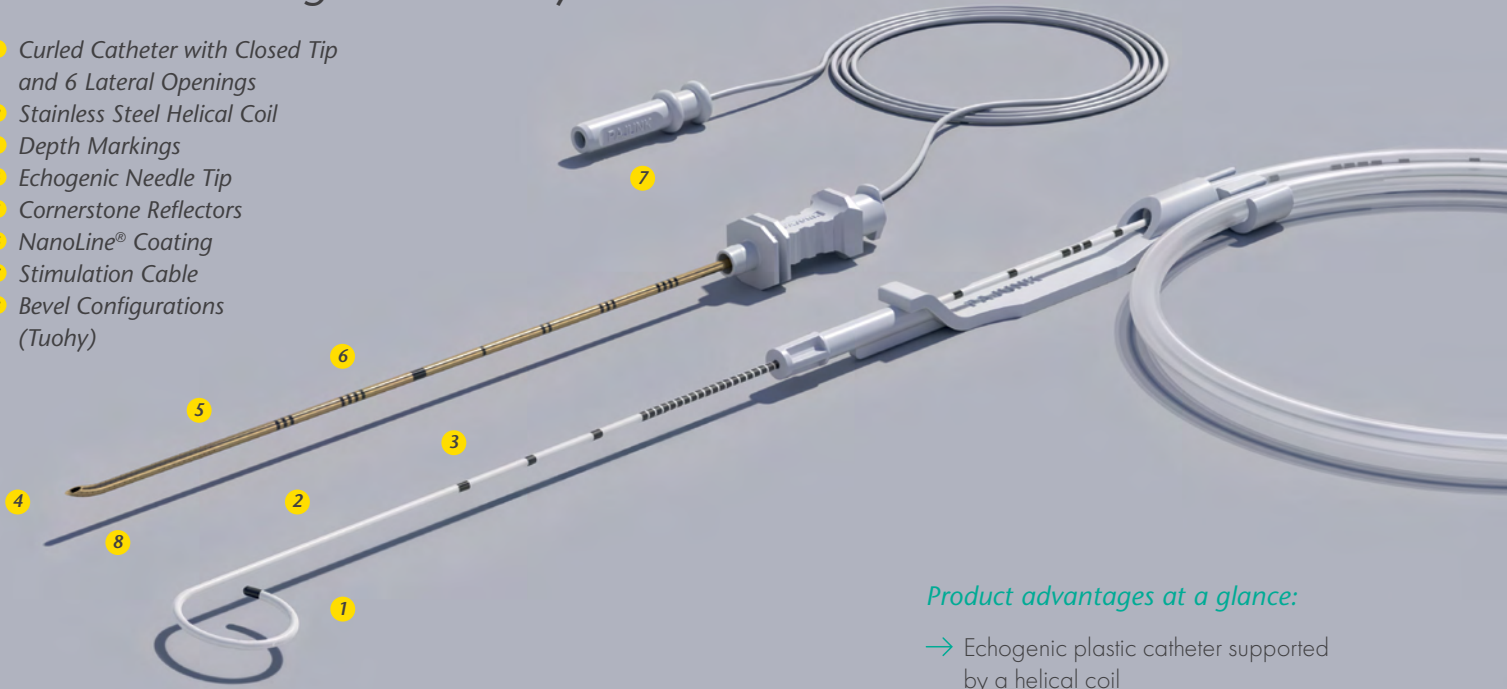

Product advantages at a glance:

- Echogenic plastic catheter supported by a helical coil
- Curled catheter with closed tip and 6 lateral eyes
- Catheter dispenser
- Stimulating

SonoLong Curl Echo with Tuohy Tip	Catheter	Item no.	PU	FixoLong	Filter	Clamping Adapter
• 18G x 50 mm (2")	20G x 50 cm (20")	531188-31C	10	•	•	•
• 18G x 50 mm (2")	20G x 90 cm (35")	531188-34C	10	•	•	•
• 18G x 100 mm (4")	20G x 90 cm (35")	521188-34C	10	•	•	•

- Small patient product

StimuLong Sono II

Stimulating Catheter-Through-Needle Systems

- 1 Stimulatable Catheter
- 2 Stainless Steel Helical Coil
- 3 Depth Markings
- 4 Echogenic Needle Tip
- 5 Cornerstone Reflectors
- 6 NanoLine Coating
- 7 Stimulation Cable
- 8 Bevel Configurations (Facet, Tuohy)

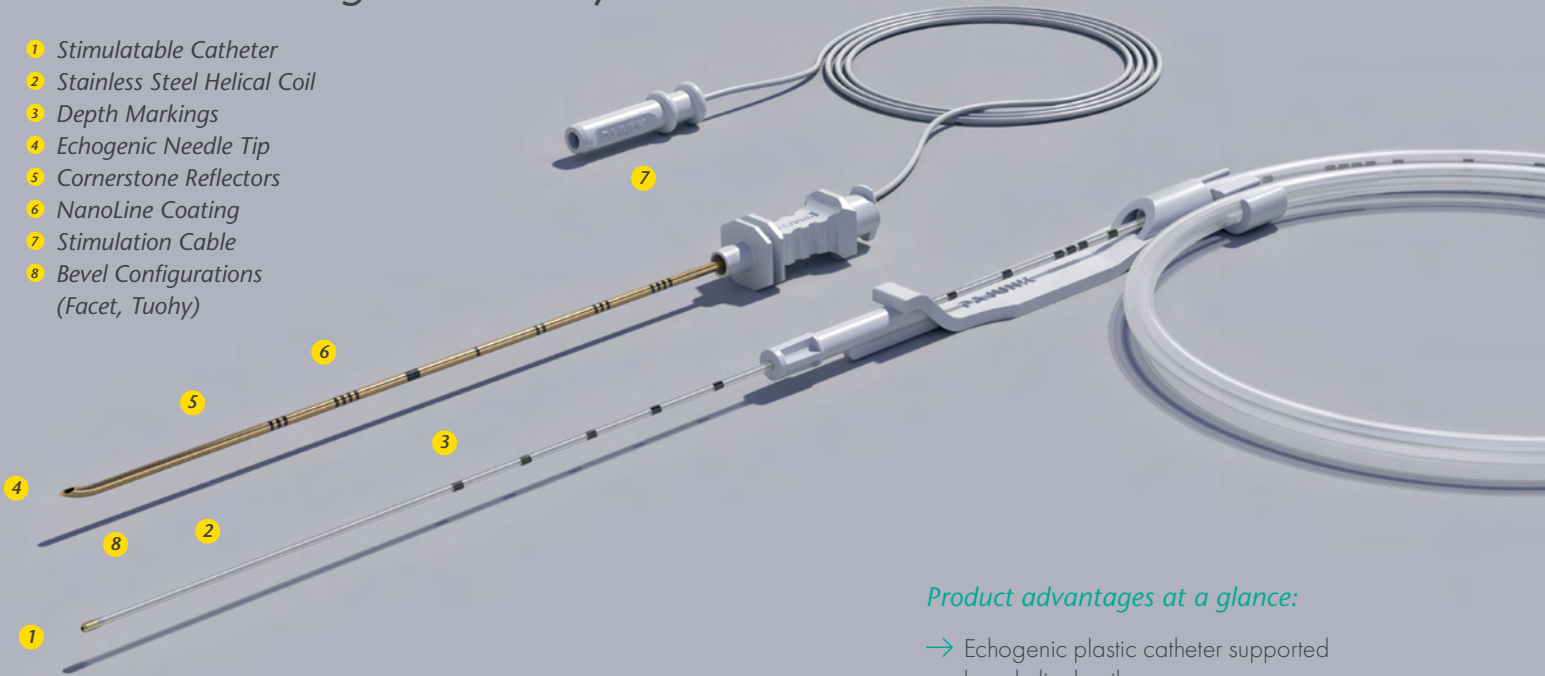

Product advantages at a glance:

- Echogenic plastic catheter supported by a helical coil
- Rounded stimulating catheter tip
- Catheter dispenser with automatic stylet removal
- Stimulating

StimuLong Sono II with Facet Tip	Catheter	Item no.	PU	FixoLong	Filter	StimuLong Clamping Adapter	Connecting cable
• 19G x 50 mm (2")	20G x 50 cm (20")	531187-32A	10	•	•	•	•
• 19G x 100 mm (4")	20G x 50 cm (20")	521187-32A	10	•	•	•	•

StimuLong Sono II with Tuohy Tip	Catheter	Item no.	PU	FixoLong	Filter	StimuLong Clamping Adapter	Connecting cable
• 18G x 50 mm (2")	20G x 50 cm (20")	531187-32C	10	•	•	•	•
• 18G x 100 mm (4")	20G x 50 cm (20")	521187-32C	10	•	•	•	•

• Small patient product

PlexoLong NanoLine®

Non-echogenic Catheter-Through-Needle Systems

- 1 Catheter with Open Tip
- 2 Depth Markings
- 3 NanoLine Coating
- 4 Stimulation Cable
- 5 Bevel Configurations
(Facet, Tuohy, SPROTTE®)

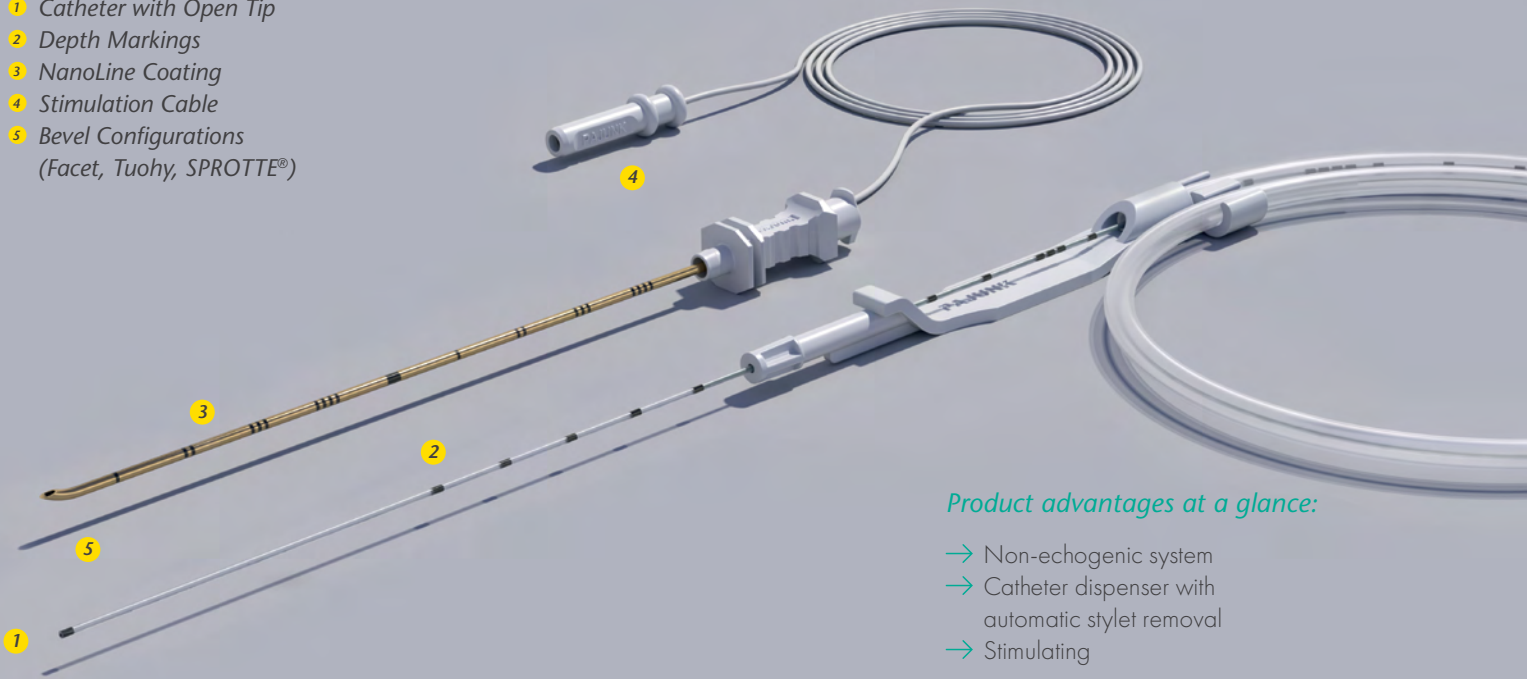

Product advantages at a glance:

- Non-echogenic system
- Catheter dispenser with automatic stylet removal
- Stimulating

PlexoLong NanoLine with Facet Tip	Catheter	Item no.	NRFit® Item no.	PU	FixoLong	Filter	Clamping Adapter
• 19G x 30 mm (1 1/5")	20G x 50 cm (20")	541156-31A		10	•	•	•
• 19G x 50 mm (2")	20G x 50 cm (20")	531156-31A	531166-31A	10	•	•	•
• 19G x 100 mm (4")	20G x 50 cm (20")	521156-31A	521166-31A	10	•	•	•
• 19G x 150 mm (6")	20G x 50 cm (20")	511156-31A	511166-31A	10	•	•	•

PlexoLong NanoLine with Sprotte Special Tip	Catheter	Item no.	NRFit Item no.	PU	FixoLong	Filter	Clamping Adapter
• 19G x 60 mm (2 1/4")	20G x 50 cm (20")	531156-31B	531166-31B	10	•	•	•
• 19G x 120 mm (4 3/4")	20G x 50 cm (20")	521156-31B	521166-31B	10	•	•	•
• 19G x 150 mm (6")	20G x 50 cm (20")	511156-31B	511166-31B	10	•	•	•

PlexoLong NanoLine with Tuohy Tip	Catheter	Item no.	NRFit Item no.	PU	FixoLong	Filter	Clamping Adapter
• 18G x 50 mm (2")	20G x 50 cm (20")	531156-31C	531166-31C	10	•	•	•
• 18G x 100 mm (4")	20G x 50 cm (20")	521156-31C	521166-31C	10	•	•	•
• 18G x 100 mm (4")	20G x 90 cm (35")	521156-34C		10	•	•	•
• 18G x 150 mm (6")	20G x 50 cm (20")	511156-31C	511166-31C	10	•	•	•

• Small patient product

A series of horizontal dashed lines for writing notes.

MultiStim ECO

Dual-Guidance Nerve Block Stimulator

- 1 Direct Needle Connection
- 2 Fixation Directly on the Patient
- 3 Adaptable Patient Cable



Product advantages at a glance:

- Limited, easy settings
- Snap-on button
- Direct connection to the needle

Description	Item no.	PU
MultiStim ECO with device case	1151-94-50	1
Extension cable for connecting stimulation needles, autoclavable	01151-861F	10
Extension cable for connecting stimulation needles and stimulators, disposable	01151-861Q	10
PlugX – patient cable with plug 2.0 mm for needle and clamp adapter for electrode	1151-94-21	1

MultiStim SENSOR

Advanced Nerve Block Stimulator

- 1 PEG (Percutaneous Electrode Guidance) Optional
- 2 Large Display



Product advantages at a glance:

- Large, clearly arranged display
- Analog current dial
- Safety features

Description	Item no.	PU
MultiStim SENSOR with device case and patient cable for needle / electrode connection	1151-94-30	1
MultiStim SENSOR with device case and patient cable for needle / stimulation handle / electrode connection	1151-94-32	1
Extension cable for connecting stimulation needles, autoclavable	01151-861 F	10
Extension cable for connecting stimulation needles and stimulators, disposable	01151-861 Q	10
Patient cable with plug 2.0 mm for needle and clamp adapter for electrode	1151-94-13	1
Patient cable with plug 2.0 mm for needle, clamp adapter for electrode and connector for monopolar handle	1151-94-14	1
Stimulation handle, monopolar	1151-94-17	1
Stimulation handle, monopolar with 1 ball electrode 10 mm diameter	1151-94-18	1

Nimbus® II PainPRO

Post-Op Pain Pump

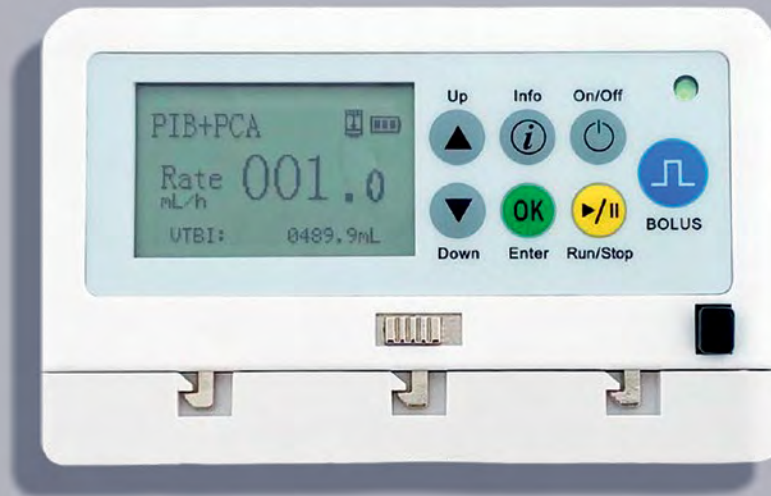

Product advantages at a glance:

- Programmable with your 12 infusion protocol presets
- 3 infusion modes: automated bolus, patient demand bolus, continuous rate
- Infuses from any vendor's IV bag of anesthetic
- Informative display screen
- Delay Start option
- Recyclable pump

Description	Item no.	NRFit® Item no.	PU
CB-500 Nimbus II PainPRO ambulatory Pump kit 1x IT1053 Nimbus II PainPro pump, 500ml carry pouch, Patient IFU manual, patient quick reference guide, shipping box, USPS return label	IT1055-PJNK-USA		1
DP-1000 Dual Nimbus II PainPRO Pump kit 2x IT1053 Nimbus II PainPro pumps, (1) Transfer set with bag spike and two luer locks, 1000 ml carry pouch, patient IFU manual, patient quick reference guide, shipping box, USPS return label (cassettes sold separately)	IT1056-PJNK-USA		1
CB-1000 Nimbus II PainPRO large volume ambulatory Pump kit 1x IT1053 Nimbus II PainPro pump, 1000ml carry pouch, Patient IFU manual, patient quick reference guide, shipping box, USPS return label	IT1068-PJNK-USA		1
HS-002 Nimbus administration set , bag spike, 0.2 Micron air-eliminating filter	IT1065		20
HS-002-N Nimbus administration set , 0.2 Micron air-eliminating filter, NRFit connector		IT1085	20
HS-102-N Nimbus administration set , 0.2 Micron air-eliminating filter, yellow stripe, NRFit connector		IT1089	20

Wound Infiltration

Wound Infiltration Solutions



InfiltraLong

Continuous Wound Infiltration Sets

- 1 Precise Microperforation
- 2 Consistent Homogeneous Flow
- 3 Fenestration Area Marking
- 4 Stainless Steel Helical Coil
- 5 Catheter Options – Standard or Forte

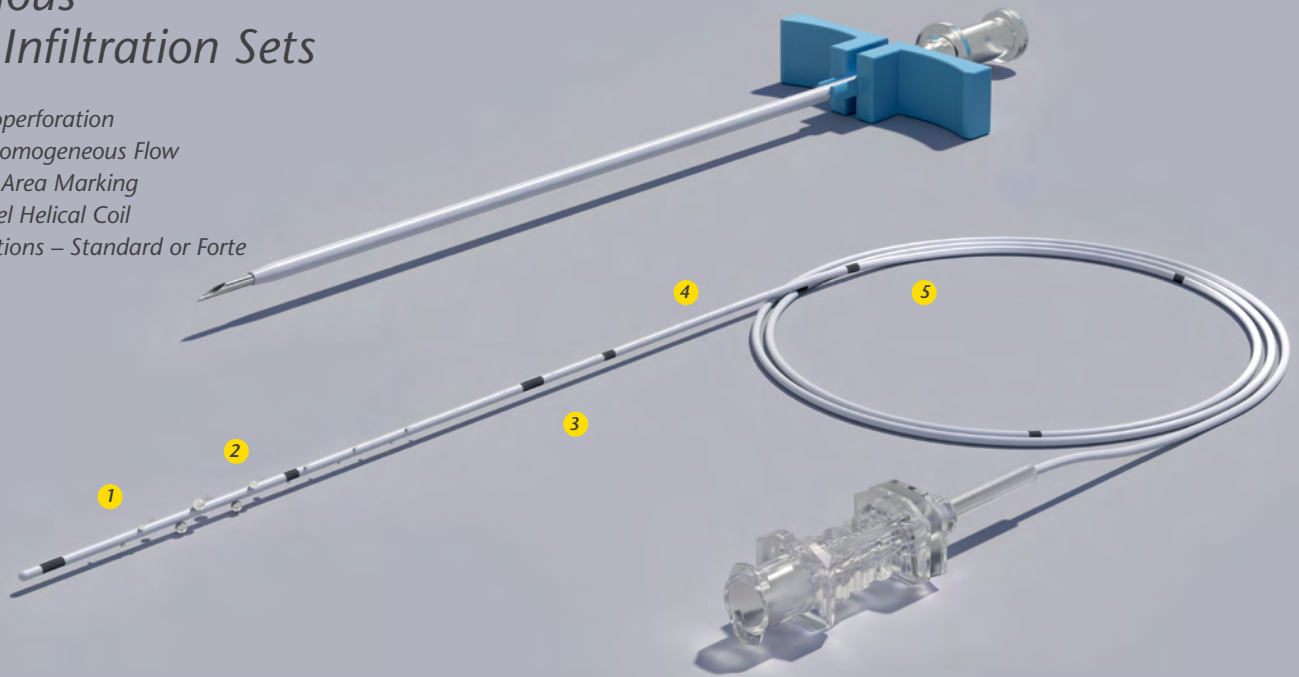

Product advantages at a glance:

- 360 degree arrangement for close, evenly spaced, fine infusion perforations²
- More effective pain relief²
- Infusion reaches its target by the fastest and most direct route²
- Kink resistant

InfiltraLong / InfiltraLong Forte

incl. split needle with puncture needle, Filter, FixoLong

Description	Item no. Standard catheter 19G	Item no. Forte catheter 18G	NRFit® Item no. Forte catheter 18G	PU
InfiltraLong 420 InfiltraLong catheter 420 mm (16 1/2"), with flexible helical coil and 10 openings along the first 25 mm	001158-00D			10
InfiltraLong (Forte) 420 InfiltraLong catheter 420 mm (16 1/2"), with flexible helical coil and 15 openings along the first 40 mm	001158-00Z	001158-01Z	001168-01Z	10
InfiltraLong (Forte) 500 InfiltraLong catheter 500 mm (19 1/2"), with flexible helical coil and 30 openings along the first 75 mm	001158-10A	001158-11A	001168-11A	10
InfiltraLong (Forte) 600 InfiltraLong catheter 600 mm (23 1/2"), with flexible helical coil and 60 openings along the first 150 mm	001158-20B		001168-21B	10
InfiltraLong (Forte) 600 InfiltraLong catheter 600 mm (23 1/2"), with flexible helical coil and 45 openings along the first 100 mm	001158-20D		001168-21D	10
InfiltraLong (Forte) 700 InfiltraLong catheter 700 mm (27 1/2"), with flexible helical coil and 88 openings along the first 220 mm	001158-30C		001168-31C	10
InfiltraLong (Forte) 900 InfiltraLong catheter 900 mm (35 2/5"), with flexible helical coil and 88 openings along the first 300 mm	001158-40C			10

² Campolo M., Molin D., Rawal N., Soldati A. Protocols to compare infusion distribution of wound catheters, Med. Eng. Phys. 2011 Apr; 34(3): 326–332

Accessories



EpiLong VPC, LOR, NerveGuard, Clamping Adapter, FixoCath, Filter & FixoLong, Injection Tubing, Safersonic Probe Covers, NRFit® Accessories

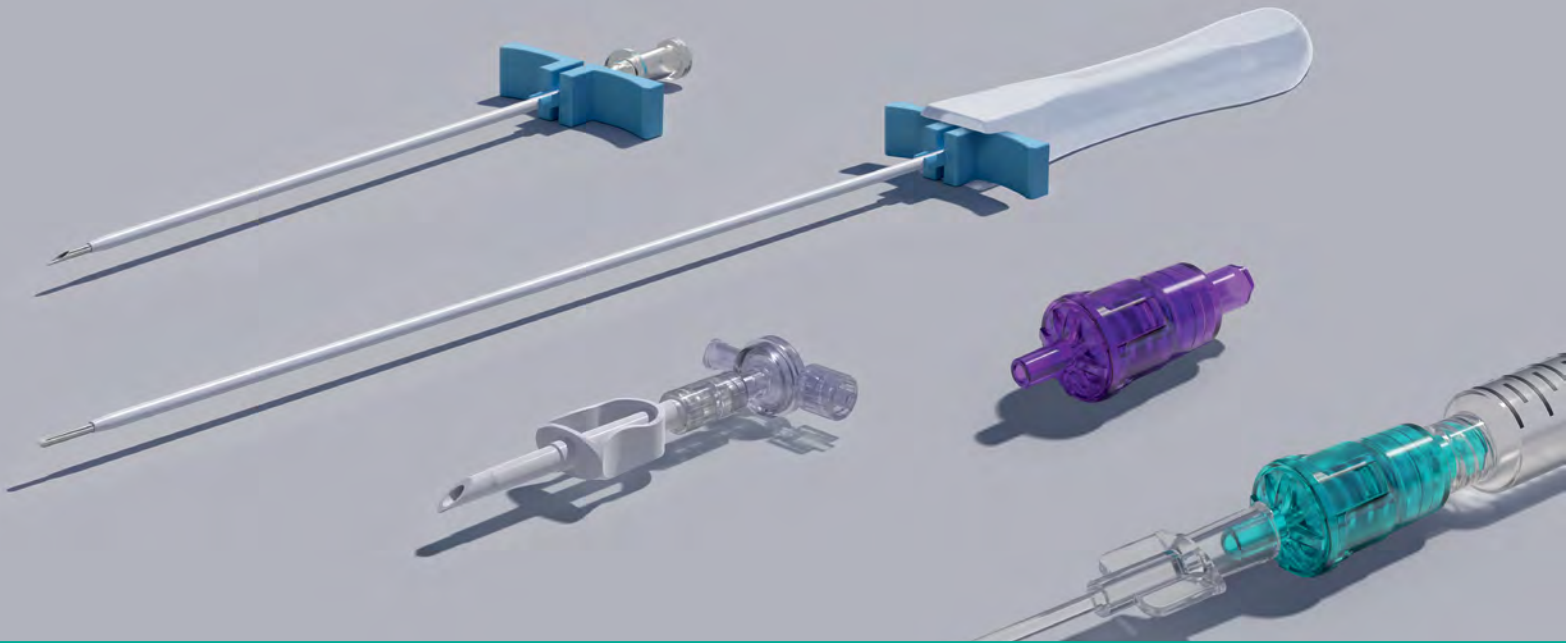

EpiLong VPC & LOR	Item no.	NRFit Item no.	PU
EpiLong VPC 10 ml, Lock	0001151-49	0001163-49	10
LOR Syringe LUER 10 ml, Lock (plastic)	0001151-45		10
NerveGuard	Item no.	NRFit Item no.	PU
for single shot applications in diamteres of 20G/21G/22G	001151-38M	001163-38M	10
for single shot applications in diamteres of 24G/25G	001151-38N	001163-38N	10

Accessories	Item no.	NRFit Item no.	PU
Clamping Adapter grey for 18G		001163-39C	10
Clamping Adapter white for 19G	001151-38C	001163-38C	10
Clamping Adapter yellow for 20G/21G/23G	001151-37V	001163-37V	10
Clamping Adapter green for 25G/27G	001151-37Y		10
FixoCath	001151-37Z		10
Filter	001151-37Q	001163-37X	10
MiniFilter	001151-38K		10
FixoLong	001151-47	001163-40	10
FixoLong Mini	001151-43		10
FixoLong with Filter	001151-48	001163-41	10
FixoLong Mini with Filter	001151-44		10
Injection Tubing 60 cm (23")	001151-37R	001163-37R	10
Injection Tubing 35 cm (14") with Y-connection	001151-37W		10

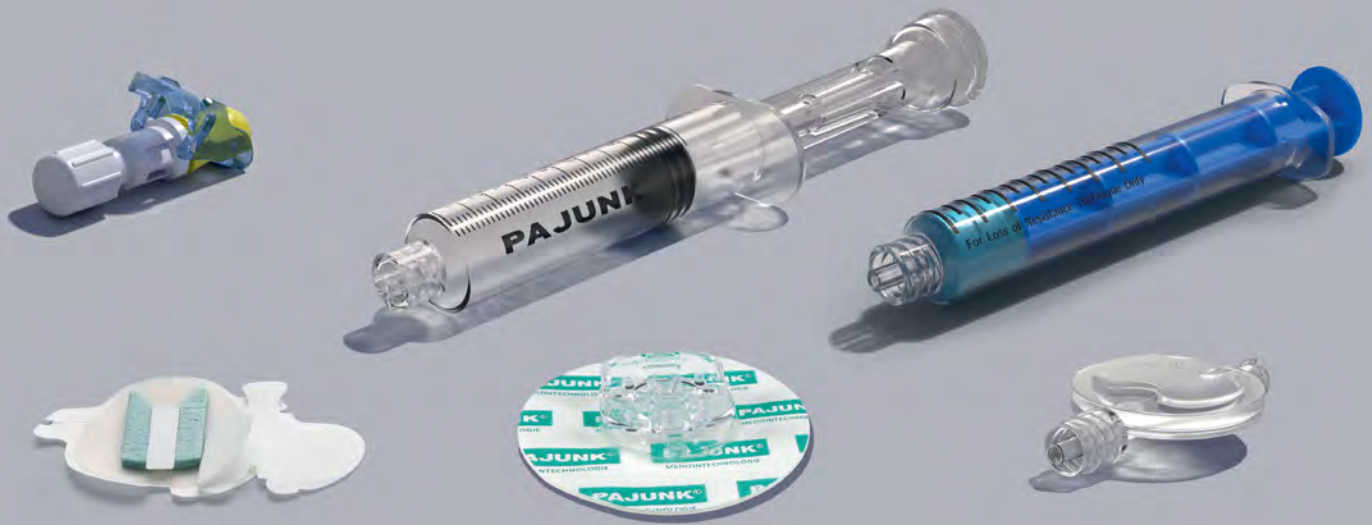

Safersonic	Item no.	PU	NRFit Accessories	NRFit Item no.	PU
18 cm x 28 cm ultrasound probe cover with gel pack, sterile	S11101	50	Blood Patch Set Tuohy needle NRFit 18G x 90 mm (3 1/2") with metal stylet, injection needle 60 cm (2 1/4"), 2 syringe 20 ml NRFit Slip, syringe 5 ml Luer Slip, LOR syringe 10 ml NRFit Slip, injection needle 21G x 38 mm (1 1/2") green, injection needle 25G x 25 mm (1") orange, filter needle 18G x 50 mm (2"), filter needle NRFit 18G x 50 mm (2"), two-way stopcock, cotton swab tweezers, 6 round swabs, 4 compress, fenestrated drape, surgical drape	001166-942	5
18 cm x 120 cm ultrasound probe cover with gel pack, sterile	S11102	50			
18 cm x 28 cm ultrasound probe cover, sterile	S11103	50			
18 cm x 120 cm ultrasound probe cover, sterile	S11104	50			
			Filter Needle 18G x 50 mm (2")	001163-38Y	10
			Locking Cap male, yellow	001163-38S	10
			Locking Cap female, yellow	001163-38Z	10



EDUCATIONAL
WEBINARS



ENSURING A HARMONIC PROCEDURE



- **Small Footprint** Trays to Save Storage Space
- **Easy to Read Tray Labels** for Fast and Easy Identification
- **High-Quality Pajunk** Components



REGIONAL ANESTHESIA PROCEDURE TRAYS

As a market leader in Regional Anesthesia, PAJUNK® offers a full range of procedural tray solutions for Spinals, Epidurals, CSEs and Nerve Blocks.

Building on our partnership with clinical users, we've created a standard offering of the most popular tray configurations on the market, in both Luer and NRFit™ options.

We understand patient outcomes are important, and having a product set up the way you want, is key to harmonic procedures.

If you don't see the exact tray configuration you need, let us create a Custom Tray solution just for you.

 **REQUEST SAMPLES NOW!**
pajunktrays.com · info@pajunk-usa.com



Procedure Trays

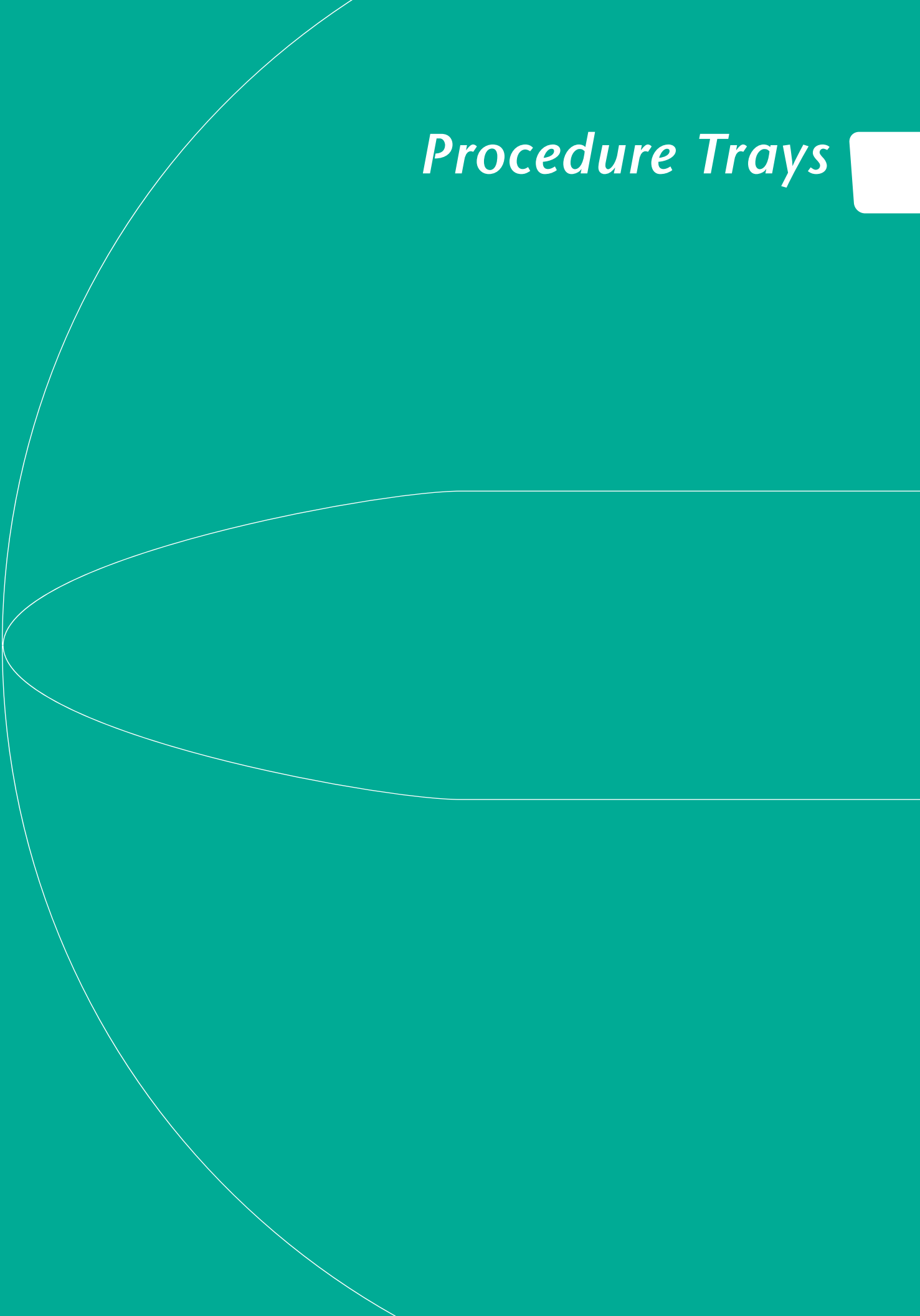

Regional Anesthesia Procedure Trays

PAJUNK® Trays Provide Quality and Convenience for your Procedures

Product advantages at a glance:

- High-Quality Pajunk Components
- Easy to Read Color-Coded Labels
- Small Footprint



Not finding the tray you're looking for?
Customize it!

Pajunk Offers a Full Range of Tray Solutions for Neuraxial and PNB Procedures, including Support and Custom Tray Options



Single Shot Nerve Block Trays

	Item no.	NRFit® Item no.
SonoPlex® II 21G x 100 mm (sterile item code 001287-77)	TDL101	TDN101
SonoPlex II 21G x 100 mm (sterile item code 001287-77) with 11" (28 cm) Safersonic probe cover and ultrasound gel	TDL131	TDN131
SonoPlex II 22G x 50 mm (sterile item code 001287-74)	TDL102	TDN102
SonoPlex II 21G x 50 mm (sterile item code 001287-74) with 11" (28 cm) Safersonic probe cover and ultrasound gel	TDL132	TDN132

Components: 3ml Tinted Chloraprep™ Applicator, 18Gx1.5" Hypodermic Needle, 25Gx1.5" Hypodermic Needle, 3 Gauze Pads, Paper Towel, CSR Wrap, 5 ml Luer Lock Syringe, 20ml Luer Lock Syringe, Needle Foam Block, Drug ID Label, 5ml 1% Lidocaine HCl

Single Shot Nerve Block Support Trays

	Item no.	NRFit Item no.
Single shot support tray, no Pajunk components	TDL109	TDN109
Single shot support tray, no Pajunk components with 11" (28 cm) Safersonic probe cover and ultrasound gel	TDL139	TDN139

Components: 3ml Tinted Chloraprep™ Applicator, 18Gx1.5" Hypodermic Needle, 25Gx1.5" Hypodermic Needle, 3 Gauze Pads, Paper Towel, CSR Wrap, 5 ml Luer Lock Syringe, 20ml Luer Lock Syringe, Needle Foam Block, Drug ID Label, 5ml 1% Lidocaine HCl

Continuous Nerve Block Support Trays

	Item no.	NRFit Item no.
Continuous Support Tray, no Pajunk components	TDL110	TDN110
Continuous Support Tray, no Pajunk components with 47" (120cm) Safersonic probe cover and ultrasound gel	TDL140	TDN140

Components: 3ml Tinted Chloraprep™ Applicator, 18Gx1.5" Hypodermic Needle, 25Gx1.5" Hypodermic Needle, 3 Gauze Pads, Paper Towel, CSR Wrap, 4" Filterstraw, 3ml Luer Lock Syringe, 5ml Luer Lock Syringe, 20ml Luer Lock Syringe, 24"x32" Clear Perforated Drape, Rectangular Fenestration, 2 4"x4.5" Film Dressings, 6 Wound Closure Strips, Skin Protectant, Needle Foam Block, Drug ID Label, 5ml 1% Lidocaine HCl

7 | PROCEDURE TRAYS

Continuous Nerve Block Trays with E-Cath®/Plus Catheter-Over-Needle (CON)

	Item no.	NRFit® Item no.
E-Cath 18G x 51 mm (2") indwelling catheter, SonoPlex® 21G x 68mm (2-2/3") (sterile item code 201285-40E)	TDL103	TDN103
E-Cath 18G x 51 mm (2") indwelling catheter, SonoPlex 21G x 68mm (2-2/3") (sterile item code 201285-40E) with 47" (120cm) Safersonic probe cover and ultrasound gel	TDL133	TDN133
E-Cath 18G x 83mm (3-1/4") indwelling catheter, SonoPlex 21G x 100mm (4") (sterile item code 241285-40E)	TDL104	TDN104
E-Cath 18G x 83mm (3-1/4") indwelling catheter, SonoPlex 21G x 100mm (4") (sterile item code 241285-40E) with 47" (120cm) Safersonic probe cover and ultrasound gel	TDL134	TDN134
E-Cath Plus 18G x 51 mm (2") indwelling catheter, SonoPlex 21G x 68mm (2-2/3") (sterile item code 201285-41E)	TDL111	TDN111
E-Cath Plus 18G x 51 mm (2") indwelling catheter, SonoPlex 21G x 68mm (2-2/3") (sterile item code 201285-41E) with 47" (120cm) Safersonic probe cover and ultrasound gel	TDL141	TDN141
E-Cath Plus 18G x 83mm (3-1/4") indwelling catheter, SonoPlex 21G x 100mm (4") (sterile item code 241285-41E)	TDL112	TDN112
E-Cath Plus 18G x 83mm (3-1/4") indwelling catheter, SonoPlex 21G x 100mm (4") (sterile item code 241285-41E) with 47" (120cm) Safersonic probe cover and ultrasound gel	TDL142	TDN142
E-Cath 18G x 100mm (4") indwelling catheter, SonoPlex 21G x 118mm (4-2/3") (sterile item code 261285-40E) with 47" (120cm) Safersonic probe cover and ultrasound gel	TDL135	TDN135
E-Cath Plus 18G x 100mm (4") indwelling catheter, SonoPlex 21G x 118mm (4-2/3") (sterile item code 261285-41E) with 47" (120cm) Safersonic probe cover and ultrasound gel (Clear Drape is Perforated)	TDL145	TDN145

Components: 3ml Tinted Chloraprep™ Applicator, 18Gx1.5" Hypodermic Needle, 25Gx1.5" Hypodermic Needle, 3 Gauze Pads, Paper Towel, CSR Wrap, 4" Filterstraw, 3ml Luer Lock Syringe, 5ml Luer Lock Syringe, 20ml Luer Lock Syringe, 24"x32" Clear Drape with 4"x6" Rectangular Opening, 2 4"x4.5" Film Dressings, 3 Wound Closure Strips, FixoCath Catheter Fixation Device, Skin Protectant, Needle Foam Block, Drug ID Label, 5ml 1% Lidocaine HCl

Continuous Nerve Block Trays with SonoLong Catheter-Through-Needle (CTN)

	Item no.	NRFit Item no.
SonoLong Echo Tuohy 18G x 100 mm 60 cm injection tubing, 60 cm stimulation cable, SonoLong Echo 20G x 23" (60 cm) echogenic catheter with closed tip and 3 lateral openings, catheter container & introducer aid, and filter with clamping adapter (sterile item code 521185-31 CU)	TDL105	TDN105
SonoLong Echo Tuohy 18G x 50 mm 60 cm injection tubing, 60 cm stimulation cable, SonoLong Echo 20G x 23" (60 cm) echogenic catheter with closed tip and 3 lateral openings, catheter container & introducer aid, and filter with clamping adapter (sterile item code 531185-31 CU)	TDL106	TDN106
SonoLong Sono Tuohy 18G x 100 mm 60 cm injection tubing, 60 cm stimulation cable, SonoLong Sono 20G x 20" (50 cm) echogenic catheter with closed tip, and 3 lateral openings, helical coil, steel stylet, catheter container & introducer aid, and filter with clamping adapter	TDL107	TDN107

Components: 3ml Tinted Chloraprep™ Applicator, 18Gx1.5" Hypodermic Needle, 25Gx1.5" Hypodermic Needle, 3 Gauze Pads, Paper Towel, CSR Wrap, 4" Filterstraw, 3ml Luer Lock Syringe, 5ml Luer Lock Syringe, 20ml Luer Lock Syringe, 24"x32" Clear Drape, Rectangular Fenestration, 2 4"x4.5" Film Dressings, 6 Wound Closure Strips, Skin Protectant, Needle Foam Block, Drug ID Label, 5ml 1% Lidocaine HCl

Spinal Trays

	Item no.	NRFit Item no.
24G x 103 mm SPROTTE® , 40mm introducer, DRY (no spinal drug) (sterile item code 021151-30A)	TBL121	TBN121
24G x 103 mm Sprotte , 40mm introducer, with spinal drug (sterile item code 021151-30A)	TBL131	TBN131
24G x 90 mm Sprotte , 30mm introducer, with spinal drug (sterile item code 121151-30A)	TBL151	TBN151
25G x 103 mm Sprotte , 40mm introducer, DRY (no spinal drug) (sterile item code 041151-29A)	TBL122	TBN122
25G x 103 mm Sprotte , 40mm introducer, with spinal drug (sterile item code 041151-29A)	TBL132	TBN132
25G x 90 mm Sprotte , 30mm introducer, with spinal drug (sterile item code 021151-29A)	TBL152	TBN152
27G x 103 mm Sprotte , 40mm introducer, with spinal drug (sterile item code 141151-27A)	TBL134	TBN134
27G x 90 mm Sprotte , 30mm introducer, with spinal drug (sterile item code 121151-27A)	TBL154	TBN154

Components: 25Gx1.5" Hypodermic Needle, 18Gx1.5" Hypodermic Needle, 1.75" Filterstraw, 3ml Luer Lock Syringe, 5ml Luer Slip Syringe, 3/4 fl. oz. Povidone-Iodine, 3 Prep Sponges, 24"x32" Clear Drape with 4" Circular Opening, 3 Gauze Pads, Paper Towel, CSR Wrap, Needle Foam Block, Drug ID Label, 5ml 1% Lidocaine HCl, 2ml 0.75% Bupivacaine HCL with 8.25% Dextrose OR Marcaine, where indicated

Continuous Epidural Trays

	Item no.	NRFit Item no.
17G x 100 mm Tuohy , 19G soft closed tip catheter, DRY (no test dose)	TAL901	TAN901
17G x 100 mm Tuohy , 19G soft closed tip catheter	TAL101	TAN101
17G x 90 mm Tuohy , 19G soft closed tip catheter	TAL151	TAN151
18G x 100 mm Tuohy , 20G nylon closed tip catheter	TAL103	TAN103

Components: Clamping Adapter, Epidural Filter, Epidural Label, 25Gx1.5" Hypodermic Needle, 18Gx1.5" Hypodermic Needle, 4" Filterstraw, Glass LOR 5ml Luer Lock Syringe, 3ml Luer Lock Syringe, 20ml Luer Lock Syringe, 3/4 fl. oz. Povidone-Iodine, 3 Prep Sponges, 4"x4.5" Film Dressing, 24"x32" Clear Drape with 4" Circular Opening, 3 Gauze Pads, Paper Towel, CSR Wrap, Needle Foam Block, Drug ID Label, 5ml 1% Lidocaine HCl, 5ml Lidocaine+Epinephrine (Test Dose), 10ml Sodium Chloride

Combined Spinal Epidural (CSE) Trays

	Item no.	NRFit Item no.
EpiSpin Lock with 17G x 90 mm (3.5") Tuohy needle with 25G x 152 mm (6") Sprotte needle and EpiLong Soft 19G x 90 cm closed tip catheter (sterile item code 0011351-20)	TCL101	TCN101
EpiSpin Lock with 17G x 90 mm (3.5") Tuohy needle with 25G x 152 mm (6") Sprotte needle and EpiLong Soft 19G x 90 cm closed tip catheter (sterile item code 0011351-20)	TCLO201	TCNO201

Components: EpiSpin Locking System consists of Tuohy needle with Back-Eye and metal stylet, wings, and locking mechanism along with Sprotte needle with magnifying hub, Clamping Adapter, Epidural Filter, Epidural Label, 25Gx1.5" Hypodermic Needle, 18Gx1.5" Hypodermic Needle, 4" Filterstraw, Glass LOR 5ml Luer Lock Syringe OR Plastic LOR 10ml Luer slip, 3ml Luer Lock Syringe, 20ml Luer Lock Syringe, 3/4 fl. oz. Povidone-Iodine, 3 Prep Sponges, 4"x4.5" Film Dressing, 24"x32" Clear Drape with 4" Circular Opening, 3 Gauze Pads, Paper Towel, CSR Wrap, Needle Foam Block, Drug ID Label, 5ml 1% Lidocaine HCl, 5ml Lidocaine+Epinephrine (Test Dose), 10ml Sodium Chloride, 2ml 0.75% Bupivacaine HCL with 8.25% Dextrose OR Marcaine, where indicated

PAJUNK®



Scan now!

PAJUNK® GmbH Medizintechnologie
Global Headquarters

Karl-Hall-Straße 1
78187 Geisingen, Germany
Tel.: +49 7704 9291-0
Fax: +49 7704 9291-600
info@pajunk.com
pajunk.com

PAJUNK® Medical Produkte GmbH
Central Europe

Karl-Hall-Straße 1
78187 Geisingen, Germany
Tel.: +49 7704 8008-0
Fax: +49 7704 8008-150
info@pajunk-medipro.com
pajunk.de & pajunk.eu

PAJUNK® Swiss AG
Switzerland

Neuhofstrasse 5A
6340 Baar, Switzerland
Tel.: +41 417 609 627

info@pajunk.ch
pajunk.ch

PAJUNK® Medical System L.P.
United States of America

4575 Marconi Drive
Alpharetta, GA 30005, USA
Tel.: +1 888 972 5865
Fax: +1 678 514 3388
info@pajunk-usa.com
pajunkusa.com

PAJUNK® UK Medical Products Ltd
United Kingdom

Unit C1 The Waterfront
Goldcrest Way, Newburn Riverside
Newcastle upon Tyne, NE15 8 NY, UK
Tel.: +44 191 264 7333
info@pajunk.co.uk
pajunk.co.uk