

PAJUNK®

**Modular System for
Monopolar Surgery with
Suction/Irrigation**

Minimally Invasive Surgery



Instructions for Use

Special notice



Please read the following information and operating instructions carefully.



Caution: Federal law restricts this device to sale by or on the order of a physician.
The device may only be used by qualified medical staff in accordance with these user instructions.

PAJUNK® does not recommend any particular treatment method. Professional medical staff are responsible for the way in which the device is used and for patient selection.

In addition to these instruction for use, the relevant information also applies according to the corresponding specialist literature and current state of the art and knowledge. Failure to comply with the user instructions invalidates the warranty and puts patient safety at risk.

If used in combination with other products, it is essential that the compatibility information and user instructions for these other products are taken into account. A decision regarding the combined use of devices from different manufacturers (where they do not constitute treatment units) is the responsibility of the user.



The device must not be used under any circumstances if there are good reasons to suspect incompleteness or damage.

Device description / compatibility

Adaptable monopolar electrodes can be combined to a modular system with the corresponding handles.

The 1299 series consists of:

REF 1299-01-00 FlowSys HF

REF 1299-11-00 Valve with HF connection

REF 1299-21-00 Two-way valve with HF connection

REF 1299-31-00 Double-valve handle with HF connection

REF 1299-41-00 FlowSys Twin HF

REF 1299-61-00 FlowSys Eco HF

REF 1299-62-00 FlowSys Eco+ HF

REF 1299-81-00 FlowSys Ergo HF

REF 1299-00-xx FlowTube HF

REF 1299-01-xx FlowTube HF-C

REF 1299-11-xx FlowTube HF-C RET

REF 1299-10-1x FlowTube HF RET

PAJUNK® GmbH Medizintechnologie recommends use of the following cables:

- REF** 1299-00-97 Storz/Erbe connection on generator side (diameter: 5 mm), socket on instrument side (diameter: 4 mm)
- REF** 1299-00-98 Valleylab connection on generator side, socket on instrument side (diameter: 4 mm)
- REF** 1299-00-99 Plug on generator side (diameter: 4 mm), socket on instrument side (diameter: 4 mm)
- REF** *Please see the current declaration of conformity for product numbers and the scope of these instructions for use.*

Electrodes for electrosurgery may only be operated with HF generators having a nominal frequency of the HF voltage between 300 kHz and 1 MHz. Lower frequencies may cause nerve stimulation and thus uncontrolled convulsion. In case of higher frequencies, user/patient safety cannot be guaranteed because insulation may heat up (at approx. 4 MHz, usual value with RF generators) so that dielectric strength is no longer given.

 The maximum operating voltage is 1.5 kVp (3000 Vss).
The maximum operating voltage for 1299-81-00 is 2.0 kVp.

 Please note the instructions for use of the HF generator.

Use only monitorable neutral electrodes compatible with the generator and monitor. For compatibilities, please refer to the instructions for use of the generator or monitor. Devices may only be used when neutral electrodes are fastened according to guidelines.

PAJUNK® instruments have a 4 mm HF connector. It can be used with HF cables with a 4 mm socket on instrument side. Electrical safety according to DIN EN 60601-1 and DIN EN 60601-2-2 standards can be guaranteed in combination with PAJUNK® cables (1299-00-xx). If other cables are used, they need minimum a 4 mm socket. Compatibility must then be checked with the cable/generator manufacturer.

Please use suction/irrigation instruments with compatible, medically approved suction/irrigation pumps and/or saline bags and tubes only. Check that the suction/irrigation tubes are safely attached on the handles.

Service life

The end of device life is determined primarily by wear, damage caused by use, careful handling and appropriate storage.

The instrument must be thoroughly checked by the manufacturer after every 200 reprocessing cycles. If the device is used after having clearly exceeded its service life, warranty expires and patient safety is put at risk. If the device is modified/manipulated (e.g. repair carried out by third parties), warranty expires and patient safety is put at risk.

Intended use

Application of high-frequency alternating current for monopolar cutting, coagulation and ablation of soft tissue.

Irrigation and aspiration of irrigation fluid in the operation field.

Indications

Open and minimally invasive surgery in the abdomen.

Contraindications

Device-specific contraindications

 *Under no circumstances is the device to be used in the event of known material incompatibilities and/or known interactions.*

Clinical contraindications

Relative: liver cirrhosis, previous hepatectomy, portal hypertension, titanium implants, disinfection using alcohol/mineral spirits, implanted electronic devices (e.g. pacemakers, ventricular support systems, neurostimulators): malfunctioning!, body piercing

Absolute: spray coagulation, lack of basic knowledge (users), ignorance and carelessness regarding the usual safety protocols

Complication

Post-ablation syndrome, treatment failure, infections, bleeding, vascular complications, pneumothorax, haemobilia, neutral electrode burns, fulminant liver failure, tumour cell scatter, injuries caused by leakage current, organ perforation, patient morbidity and mortality, burns to intra-abdominal tissues and organs, thermal damage, incorrect use of instruments, underestimation of the ablation area, miscalculation of the coagulation threshold, severe electric shock, fire in the operating room, smoke inhalation, gene mutations, burns elsewhere, burns due to capacitive coupling



Allergic reactions (Ni)

 *Users must inform patients of complications typically associated with the procedure.*

 *If complications occur while using the device, follow the protocols of your organisation. If this does not resolve the complications, or if they are regarded as serious or untreatable, carefully stop the procedure and remove invasive device components from the patient.*

Warnings

 *for reusable product:*

1.  Please make absolutely sure that you clean and sterilise all devices delivered in non-sterile condition before using them for the first time!
2.  If an instrument has been contaminated, always process it immediately after use (see instructions for manual pre-cleaning)!
3. Subject the device to a visual and functional check before every use. Check continuity of the electrode from the electrode tip to the HF connection by means of an electrical continuity tester.
4. Sort damaged or faulty instruments and replace them.
5. The service life of wearing parts is limited. Always check wearing parts for damage prior to every use, and replace them if necessary.

 *in the application:*

1. Take care to use products of suitable dimensions (diameter, length), especially when treating obese patients and children.
2. Please note that the continued use of a device of the same type must be assessed cumulatively as described in the legislation on medical devices, even after the device has been exchanged or replaced.
3. Compliance with good clinical practice and required precautions is an absolute necessity. Deep wound infections are post-interventional complications. Their elimination requires surgical interventions.
4. Introduce the instrument carefully through the trocar sleeve. This avoids damage on the distal end.

 *further warning indications:*

1. When using multiple components, familiarise yourself with their operation before use by checking connections and passages.
2. You must routinely take general precautions for handling blood and bodily fluids when using and disposing of the device, due to the risk of contact with blood-borne pathogens.

 *in combination with electrical current:*

1. Special care is required when using electrosurgery for patients with internal or external pace-makers or other active implants. Interference generated when using electrosurgical units may cause the devices, such as a pace-maker, to change to asynchronous mode or to get blocked. Please obtain information from the manufacturer of the pace-maker or from the cardiology department of a hospital when the use of electrosurgical units on a patient with pace-maker is planned.
2. Deactivate the automatic switch-on mode of the HF generator.
3. The medical devices may not be used directly next to other devices or in a

pile with other devices. If such use is inevitable, check whether the medical devices work properly in the intended configuration.

4. HF devices may affect the function of the monitors used in the procedure. The corresponding electrodes must be placed as far as possible from the treated area.
5. Use the instrument only if the rated voltage specified for the instrument is the same or higher than the maximum output voltage of the HF generator.
6. If the instrument is activated, hold it so that you always see the end you are working with. Before switching on the HF device, make sure that the end of the instrument does not touch conducting accessories or liquids.
7. Be aware of the safety risks caused by accumulation of leakage currents if several individual devices are connected to each other. This increases the probability of a risk of tissue damage.
8. The conductible parts of electrodes and the connectors for any application parts (including neutral electrode) must not get in contact with other conductible parts (including earth).
9. To avoid leakage currents, make sure that no liquids are moved in the suction/irrigation tube during coagulation with instruments with suction/irrigation function.
10. For instruments supplied with protective cap: Please make sure during use that the protective cap is present and firmly seated! There is a risk of electric shock!
11. If it is not possible to exclude contact with active instruments during endoscopic procedures, use isolated accessories. To avoid short circuits, keep a sufficiently large safety distance to other metal instruments in the surgical area.
12. Use the lowest possible setting of the output power for each indication.
13. Regularly check accessories, in particular, live parts and endoscopic accessories.
14. For safety reasons, make sure that the connected supply line does not get in contact with the patient.

Dismantling

Adaptable monopolar HF electrode, one piece (1299-00-xx, 1299-01-xx)



1299-00-xx



1299-01-xx (with ceramic tip)

Adaptable monopolar HF electrode, one piece (1299-00-xx, 1299-01-xx)

Disassembly from valve handle



- 1) Hold the grooved part of the electrode hub with one hand and the grooved part of the handle with your other hand.
- 2) Turn both parts in anti-clockwise direction to loosen the Luer-Lock connection.
- 3) Now clean the components according to the instructions in chapter "Processing".
- 4) Perform maintenance according to the instructions in chapter "Maintenance, inspection and care"!

Retractable monopolar HF electrode, dismantlable (1299-10-1x, 1299-11-xx)

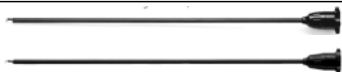

1299-10-xx

1299-11-xx (with ceramic tip)

Disassembly from valve handle



- 1) Retract the electrode tip completely.



- 2) Hold the grooved part of the electrode hub with one hand and the grooved part of the handle with your other hand.
- 3) Turn both parts in anti-clockwise direction to loosen the Luer-Lock connection.

Disassembling the electrode



- 1) Hold the grooved hub in one hand and the setting wheel in your other hand and turn both parts in anti-clockwise direction.
- 2) The plastic tube can be pulled off the stainless steel tube, and the setting wheel can be removed.
- 3) Now clean the components according to the instructions in chapter "Processing".
- 4) Perform maintenance according to the instructions in chapter "Maintenance, inspection and care"!

Suction/irrigation handle with monopolar coagulation (1299-01-00)



Complete instrument.

Dismantling



- 1) Unscrew the nut on the valve piston/tappet completely. Pull the valve piston/tappet upwards out of the instrument.
- 2) Unscrew the cap at the bottom of the valve completely and remove it.
- 3) The O-ring of the Luer swivel adapter must be removed.
- 4) Now clean the components according to the instructions in chapter "Processing".
- 5) Perform maintenance according to the instructions in chapter "Maintenance, inspection and care"!

Valve with monopolar coagulation (1299-11-00)



1) Valve cock

2) Valve body

3) Spring cap

Dismantling



Complete instrument.





- 1) Unscrew the spring cap on the bottom of the cock.

	<p>2) Pull the valve cock upwards out of the instrument.</p> <p>3) The O-ring of the Luer swivel adapter must be removed.</p> <p>4) Now clean the components according to the instructions in chapter "Processing".</p> <p>5) Perform maintenance according to the instructions in chapter "Maintenance, inspection and care"!</p>
---	--

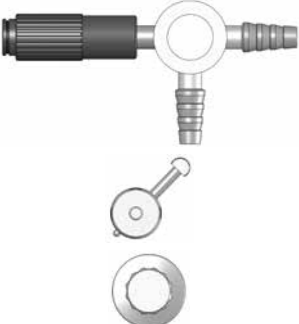
Two-way valve with monopolar coagulation (1299-21-00)

	<p>1) Valve body</p> <p>2) Valve cock</p> <p>3) Holding plate</p>
--	---

Dismantling

	<p>Complete instrument.</p>
	<p>1) Unscrew the suspended holding plate completely from the valve cock.</p>
	<p>2) Press the valve cock down until it gets loose from the valve body.</p> <p>3) The O-ring of the Luer swivel adapter must be removed.</p> <p>4) Now clean the components according to the instructions in chapter "Processing".</p> <p>5) Perform maintenance according to the instructions in chapter "Maintenance, inspection and care"!</p>

Double-valve handle with monopolar coagulation (1299-31-00)

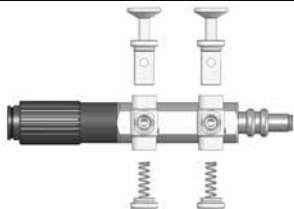

1) Valve pistons/tappets (2)

2) Valve body

3) Caps (2)

Dismantling



Complete instrument.



1) Unscrew the nuts on both valve pistons/tappets completely. Pull the two valve pistons/tappets upwards out of the instrument.

2) Unscrew the two caps at the bottom of the valve completely and remove them.

3) The O-ring of the Luer swivel adapter must be removed.

4) Now clean the components according to the instructions in chapter "Processing".

5) Perform maintenance according to the instructions in chapter "Maintenance, inspection and care"!

Suction/irrigation handle (1299-41-00)



1) Valve pistons/tappets (2)

2) Springs (2)



3) Body



4) Grip plate

Suction/irrigation handle (1299-41-00)

Dismantling



Complete instrument.



1) Press the suspended button on the grip plate and pull the black grip plate downwards while keeping the button pressed.



2) Unscrew the nuts on both valve pistons/tappets completely. Pull the two valve pistons/tappets upwards out of the instrument.

3) The springs are loosely fastened to the valve pistons/tappets and can be removed.

4) The O-rings of the Luer swivel adapter and the body must be removed.

5) Now clean the components according to the instructions in chapter "Processing".

6) Perform maintenance according to the instructions in chapter "Maintenance, inspection and care"!

Pistol handle with monopolar coagulation (1299-61-00, FlowSys Ergo HF 1299-81-00)









1 Handle

2 Valve cock

3 Holding plate

Pistol handle with monopolar coagulation (1299-61-00, FlowSys Ergo HF 1299-81-00)

Disassembly:

		Complete instrument
		1) Unscrew the suspended holding plate completely from the valve cock.
		2) Press the valve cock down until it gets loose from the valve body. 3) The O-ring of the Luer swivel adapter must be removed. 4) Now clean the components according to the instructions in chapter "Processing". 5) Perform maintenance according to the instructions in chapter "Maintenance, inspection and care"!

Assembly

Adaptable monopolar HF electrode, one piece (1299-00-xx, 1299-01-xx)

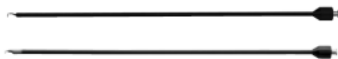







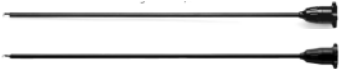

1299-00-xx

1299-01-xx (with ceramic tip)

Mounting on the valve handle



- 1) Hold the grooved part of the electrode hub with one hand and the grooved part of the handle with your other hand.
- 2) Turn both parts in clockwise direction as far as they will go to fasten the Luer-Lock connection.
- 3) Now sterilise the components according to the instructions in chapter "Processing".

Retractable monopolar HF electrode, dismantlable (1299-10-1x, 1299-11-xx)	
	1299-10-xx 1299-11-xx (with ceramic tip)
Mounting the electrode	
	The disassembled instrument consists of stainless steel tube, plastic tube with grooved hub and setting wheel.
	1) Insert the stainless steel tube with the electrode tip first through the grooved hub into the plastic tube.
	2) Make sure that the hexagonal hub of the stainless steel tube is advanced up to the stop.
	3) Screw the setting wheel on.
	4) Test its function after assembly.
Mounting on the valve handle	
	1) Retract the electrodes completely.
	2) Hold the grooved part of the electrode hub with one hand and the grooved part of the handle with your other hand.
	3) Turn both parts in clockwise direction as far as they will go to fasten the Luer-Lock connection.
	4) Now sterilise the components according to the instructions in chapter "Processing".
Suction/irrigation handle with monopolar coagulation (1299-01-00)	
	Complete instrument.

Suction/irrigation handle with monopolar coagulation (1299-01-00)

Assembly



The disassembled instrument consists of body, cap and valve piston/tappet.

- 1) Carefully put the greased valve piston/tappet into the opening of the valve. Make sure that the small pin in the opening engages in the unilateral groove on the valve piston/tappet.
- 2) Put the cap onto the bottom side of the instrument and screw it tight against the spring force.
- 3) Now sterilise the components according to the instructions in chapter "Processing".

Valve with monopolar coagulation (1299-11-00)



1) Valve cock

2) Valve body

3) Spring cap

Assembly



The disassembled instrument consists of valve cock, valve body and spring cap.



1) Carefully put the valve cock in the valve body. Make sure that the small pin engages in the unilateral groove.



2) Put the spring cap onto the bottom side of the instrument and screw it tight against the spring force.

3) Now sterilise the components according to the instructions in chapter "Processing".

Two-way valve with monopolar coagulation (1299-21-00)

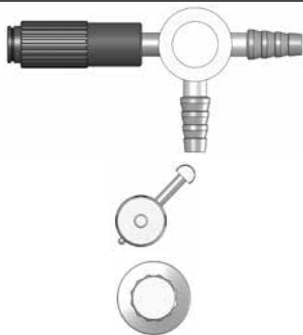

1) Valve body

2) Valve cock

3) Holding plate

Assembly



The disassembled instrument consists of valve body, valve cock and holding plate.

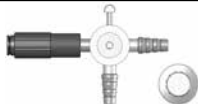

1) Put the valve cock in the valve body. Please make sure that the lug of the valve cock engages in the unilateral groove on the valve body.

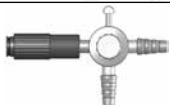

2) Screw the suspended holding plate onto the threaded pin of the valve cock and screw it tight.
3) Now sterilise the components according to the instructions in chapter "Processing".

Double-valve handle with monopolar coagulation (1299-31-00)

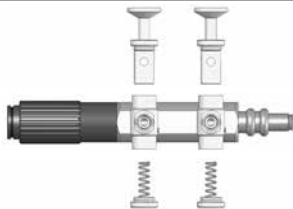

1) Valve pistons/tappets (2)

2) Valve body

3) Caps (2)

Double-valve handle with monopolar coagulation (1299-31-00)

Assembly



The disassembled instrument consists of valve body, 2 valve tappets/pistons and 2 caps.



1) Carefully put the greased valve pistons/tappets into the openings of the valve. Make sure that the small pins in the opening engage in the unilateral grooves on the valve pistons/tappets.



2) Put the caps onto the bottom side of the instrument and screw them tight against the spring force.
3) Now sterilise the components according to the instructions in chapter "Processing".

Suction/irrigation handle (1299-41-00)



1) Valve pistons/tappets (2)

2) Springs (2)



3) Body



4) Grip plate

Suction/irrigation handle (1299-41-00)

Assembly



The disassembled instrument consists of body, grip plate, the two valve pistons/tappets and springs.

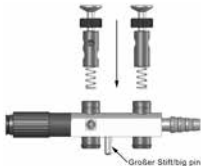

1) Carefully put the spring in the greased valve piston/tappet.

Then insert the piston/tappet with one (1) hole carefully into the valve opening pointing towards the tube connection, and the one with two (2) holes into the valve opening pointing away from the tube connection. Make sure that the small pin in the opening engages in the unilateral groove on the valve piston/tappet.



2) Slide the black grip plate from below onto the instrument while keeping the button pressed. Make sure that the large pin between the two valve openings engages in the corresponding groove of the grip plate.

3) Now sterilise the components according to the instructions in chapter "Processing".

Pistol handle with monopolar coagulation (1299-61-00, FlowSys Ergo HF 1299-81-00)









1 Handle

2 Valve cock

3 Holding plate

Pistol handle with monopolar coagulation (1299-61-00, FlowSys Ergo HF 1299-81-00)

Assembly:

		<p>The disassembled instrument consists of handle, valve cock and holding plate.</p>
		<p>1) From the rear, push the valve cock completely into its middle position.</p>
		<p>2) Screw the suspended holding plate onto the threaded pin of the valve cock and screw it tight.</p> <p>3) Now sterilise the components according to the instructions in chapter "Processing".</p>

Processing

General information

- 

Whenever you are working with contaminated instruments, follow the personal protection guidelines of the trade association and similar organisations. Wear appropriate protective equipment and ensure that you have had the necessary vaccinations.
- 

Risk of infection: Incorrect processing of instruments puts patients, users and third parties at risk of infection and can impair the performance of the instrument.
- 

Instruments used on patients known to have or suspected of having Creutzfeldt-Jakob disease or other prion diseases must be disposed of after one use in accordance with specific national requirements.
- 

Always comply with the procedures, equipment and devices validated for the user / operator / central sterilisation unit and check them for compatibility with the information provided here.
- 

When making up and using solutions, comply with the information on concentration and exposure time provided by the manufacturers of the chemicals. Non-compliance can damage the instrument.

 Further information on instrument processing can be found at www.a-k-i.org

Preparation at the place of use

If an instrument has been contaminated, always clean it immediately after use. To prevent material from drying and adhering to the instrument, large particles of contamination, corrosive solutions and medicinal products must be removed immediately after application of the medicinal product, for example by wiping and rinsing (dry disposal).

Transport

Use suitable transport containers to transport instruments to the reprocessing site in order to rule out the possibility of them constituting a hazard or undergoing external contamination.

Dry disposal is always preferred, whenever possible. Avoid long storage times.

Preparation before mechanical cleaning

If an instrument has been contaminated, always process it immediately after use. If the instrument is a multi-piece device, dismantle it into its constituent parts (see chapter on instructions for dismantling).

Pre-cleaning the surfaces:

Use a brush (no steel brush) or sponge to remove visible contamination or heavy dirt from the surface of the instrument under cold running water (<40 °C; drinking water quality).

Pre-cleaning cavities / lumens:

Use a suitable brush (no steel brush) to clean the working channels, lumens and cavities of the instrument under cold running water (<40 °C; drinking water quality). Rinse gaps, grooves and cavities approx. 10 seconds with a pressurised water pistol, fitted with an irrigation attachment if necessary.

Manual cleaning / manual disinfection

Manual disinfection is not necessary.

 **Warning:** Exclusively manual processing is not permitted. Manual cleaning must always be followed by mechanical cleaning and disinfection.

Mechanical cleaning and disinfection

Instrument sets must only be cleaned and disinfected in a suitable cleaning and disinfection machine (CDM).

Use the Vario TD programme to clean thermostable instruments.

PAJUNK® has validated and approved the following cleaning and disinfection process in accordance with DIN EN ISO 17664 or DIN EN ISO 15883:

- Vario TD process parameters:
 - 1 minute pre-washing with cold tap water, drinking water quality, <40 °C
 - Draining
 - 3 minute pre-cleaning with cold tap water, drinking water quality, <40 °C
 - Draining

If Neodisher® Mediclean forte is used:

- 10 minutes cleaning at 55 °C (+5/-1 °C), dosage acc. to the following table and demineralised water

If Neodisher® MediZym is used:

- 10 minutes cleaning at 45 °C (+5/-1 °C), dosage acc. to the following table and demineralised water
- Draining
- 3 minutes rinsing with demineralised water (<40 °C)
- Draining
- 2 minutes rinsing with demineralised water (<40 °C)
- Draining
- 5 minutes thermal disinfection at 93 °C (± 2 °C) (A0 =3000) and demineralised water
- Draining
- 30 minutes hot air drying at >60 °C (in the cleaning chamber)

Chemical	Manufacturer	Category	pH value	Dosage
Neodisher Mediclean forte	Dr. Weigert	Alkaline detergent	10.4 - 10.8*	0.5 % (5 ml/l)
Neodisher MediZym	Dr. Weigert	Enzymatic detergent	7.6 - 7.7 *	0.5 % (5 ml/l)

* Data in accordance with manufacturer data sheet

Connect individual parts with lumens and channels directly to the cleaning and disinfection machine. Connect non-dismountable instrument sets with cleaning channel, if any, directly on the Luer-Lock port to the special lumen-cleaning element in the cleaning and disinfection machine.

When selecting the cleaning programme, bear in mind the material from which the instrument to be cleaned is made (e.g. stainless steel for medical instruments, chromed surface, aluminium).

 Always comply with the instructions of the device and detergent manufacturers.

Drying

 The instrument may need to be manually dried after cleaning.

Maintenance, inspection and care

Leave the instrument set to cool to room temperature.

Perform a visual check on the cleaned and disinfected instrument, paying attention to cleanliness, completeness, damage and dryness.

If any contamination or residue is found during this check, the instrument must undergo another complete cleaning and disinfection process.

Any parts of the instrument that are found to be damaged, incomplete, corroded, bent, broken, torn or worn must be removed or replaced.

Always check O-rings for damage prior to use, and replace them if necessary.

Dry the instrument again if there is any residual moisture.

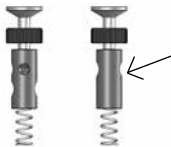

For articles 1299-01-00, 1299-31-00 and 1299-41-00: grease the valve piston/tap-pets using a suitable grease (PAJUNK® art. no. 1298-98).

Reassemble the dismantled instrument set according to the assembly instructions.

! PAJUNK® recommends that instruments be handled carefully and gently, and that this user manual be closely followed, in order to maximise their useful life. The useful life of the instrument depends to a very large extent on careful handling and the performance of appropriate care and maintenance measures.

Packaging system

Only use standardised and permitted packaging systems in accordance with EN 868 parts 2-10, EN ISO 11607 parts 1+2, DIN 58953.

Sterilisation

⚠ *Warning: Instruments used on patients known to have or suspected of having Creutzfeldt-Jakob disease or other prion diseases must be disposed of after one use in accordance with specific national requirements.*

PAJUNK® has validated and approved the following process:

Steam sterilisation:

The fully mounted instrument must be sterilised in accordance with a validated steam sterilisation process (e.g. steriliser according to DIN EN 285 and validated according to DIN EN 17665-1).

When following the fractionated vacuum procedure, sterilise according to the 134 °C/ 3-bar programme, with a minimum holding time of 5 minutes (in accordance with the recommendations issued by the Robert Koch Institute and the German Federal Institute for Drugs and Medical Devices). The drying time is 30 minutes.

Allow devices / instruments to cool to room temperature before using them again. Keep instrument sets that have undergone steam sterilisation in suitable containers used only for this purpose.

Transport to the place of use

Use suitable transport systems.

Reprocessing restriction

The end of device life is determined primarily by wear, damage caused by use, careful handling and appropriate storage.

Frequent reprocessing in accordance with the reprocessing instructions supplied by the manufacturer does not affect the instruments' performance.





Repair

Devices sent to PAJUNK® for repair under warranty or at the user's expense must be thoroughly cleaned and sterilised before being sent back. Sterility must be noted on the covering letter or package.

Storage / operating / transport conditions





Environmentally-friendly operation / storage

Atmospheric conditions

	Temperature limit	10 °C to 30 °C
	Humidity limitation	20 % to 65 % (non-condensing)
	Pressure range	700 hPa to 1060 hPa
	Keep dry	
	Keep away from sunlight	

Transport conditions and environmentally friendly transport

Atmospheric conditions

	Temperature limit	10 °C to 30 °C
	Humidity limitation	20 % to 65 % (non-condensing)
	Pressure range	700 hPa to 1060 hPa
	Keep dry	
	Keep away from sunlight	

Under normal, foreseeable environmental conditions, there are no known significant interactions or possible damages caused by magnetic fields, external electrical influences, electrostatic discharge, pressure or pressure changes, thermal ignition sources and accelerations.

General information

The devices are manufactured in accordance with globally applicable guidelines for hazardous substances.

 **BF-type application part**

 *Dispose of all components and materials sorted and in an environmentally friendly way or have them recycled. If the medical device is no longer used, it must be disposed of according to the country-specific environmental regulations.*

 *Any serious incident that has occurred while using the device should be reported to the manufacturer and the corresponding authorities of the country the user and/or patient are residing in.*

 PAJUNK® GmbH Medizintechnologie, Karl-Hall-Strasse 1, 78187 Geisingen, Germany.

Key to symbols used in labelling



Manufacturer



Catalogue number



Do not use if package is damaged



Keep dry



Humidity limitation



Caution



Protection against electric shock, type BF



Date of manufacture



Batch code



Non-sterile



Keep away from sunlight



Temperature limit



Pressure range



Consult instructions for use



Dispensing with prescription only (The product may only be used by qualified medical staff for the intended purpose.)



Do not dispose of with domestic waste



Advice



Information



Product is in conformity with the applicable requirements set out in Community harmonization legislation and is monitored by a notified body



Consult instructions for use (SO 7010-M002)



Quantity



Translation



Medical device



XS190173J_Englisch 2020-01-20



PAJUNK® GmbH
Medizintechnologie
Karl-Hall-Strasse 1
78187 Geisingen/ Germany
Phone +49 (0) 7704 9291-0
Fax +49 (0) 7704 9291-600
www.pajunk.com